

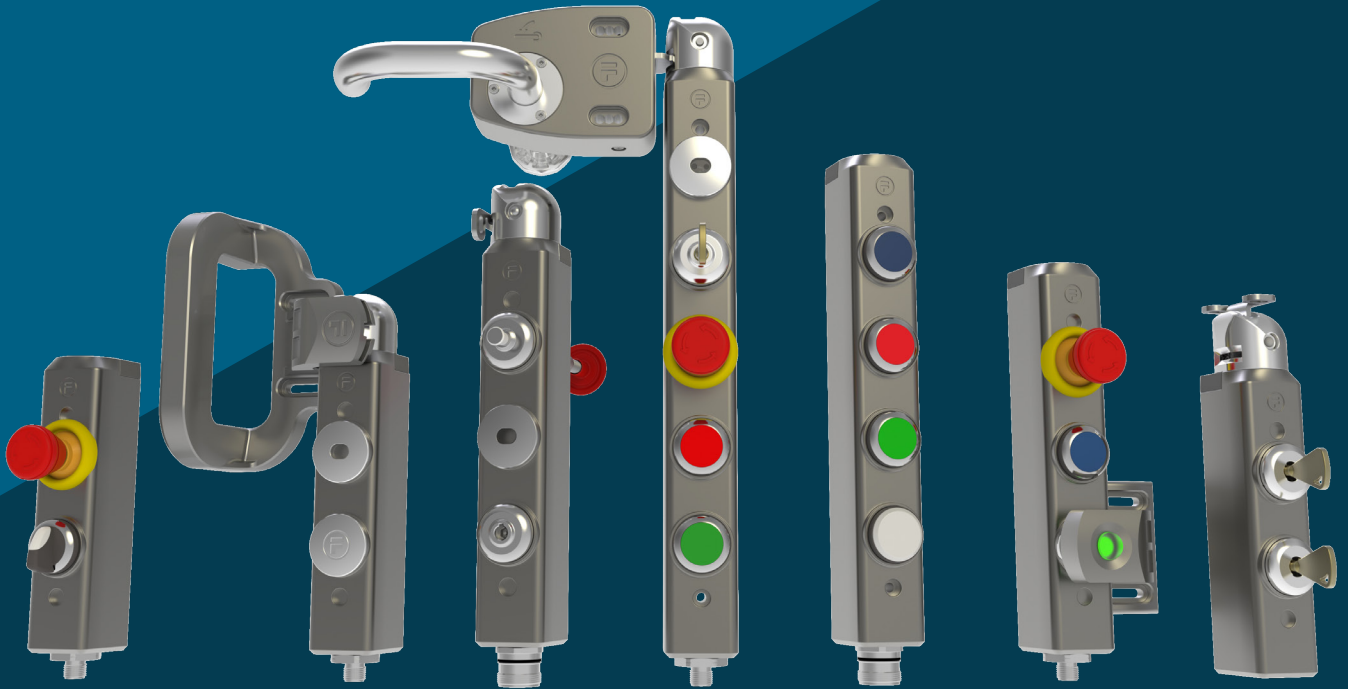

# FORTRESS



## Configurable Access & Control for Machine Guarding

**t** Gard

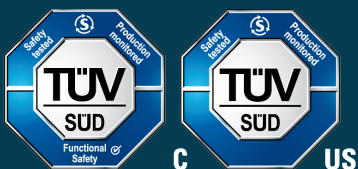

# Introduction to tGard

tGard is a compact metal bodied system that enables the configuration of interlocks with or without guard locking, mechanical trapped key interlocks, and electrical operator controls either as separate devices or any combination of these three functions in one device.

tGard offers “a customised safety solution, as standard”. Each order is defined by a range of tGard elements that include interlock safety switches, High Level Coded RFID, personnel keys, escape release, E-Stops, pushbuttons, selector switches, indicator lamps and a choice of operating handles for hinged and sliding guard doors.

tGard’s metal body includes through-holes for quick installation on aluminium profiles, flat surfaces, doors and even back of panels without the need for mounting plates.

tGard is IP65 as standard and has been designed to be fully compliant with machinery safety standards.

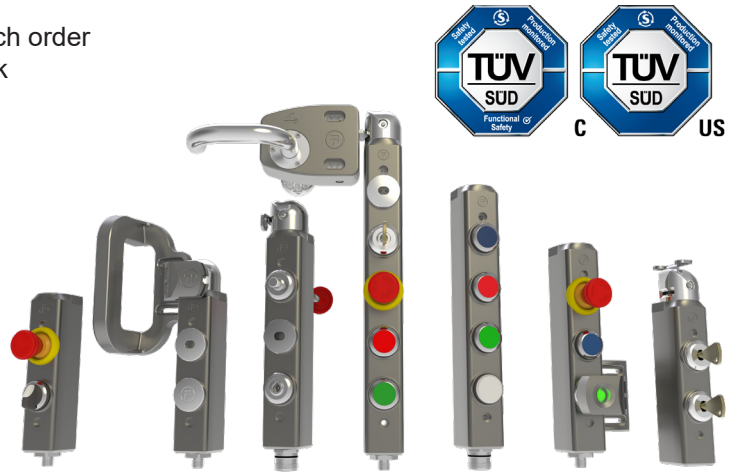

## Configuration Example

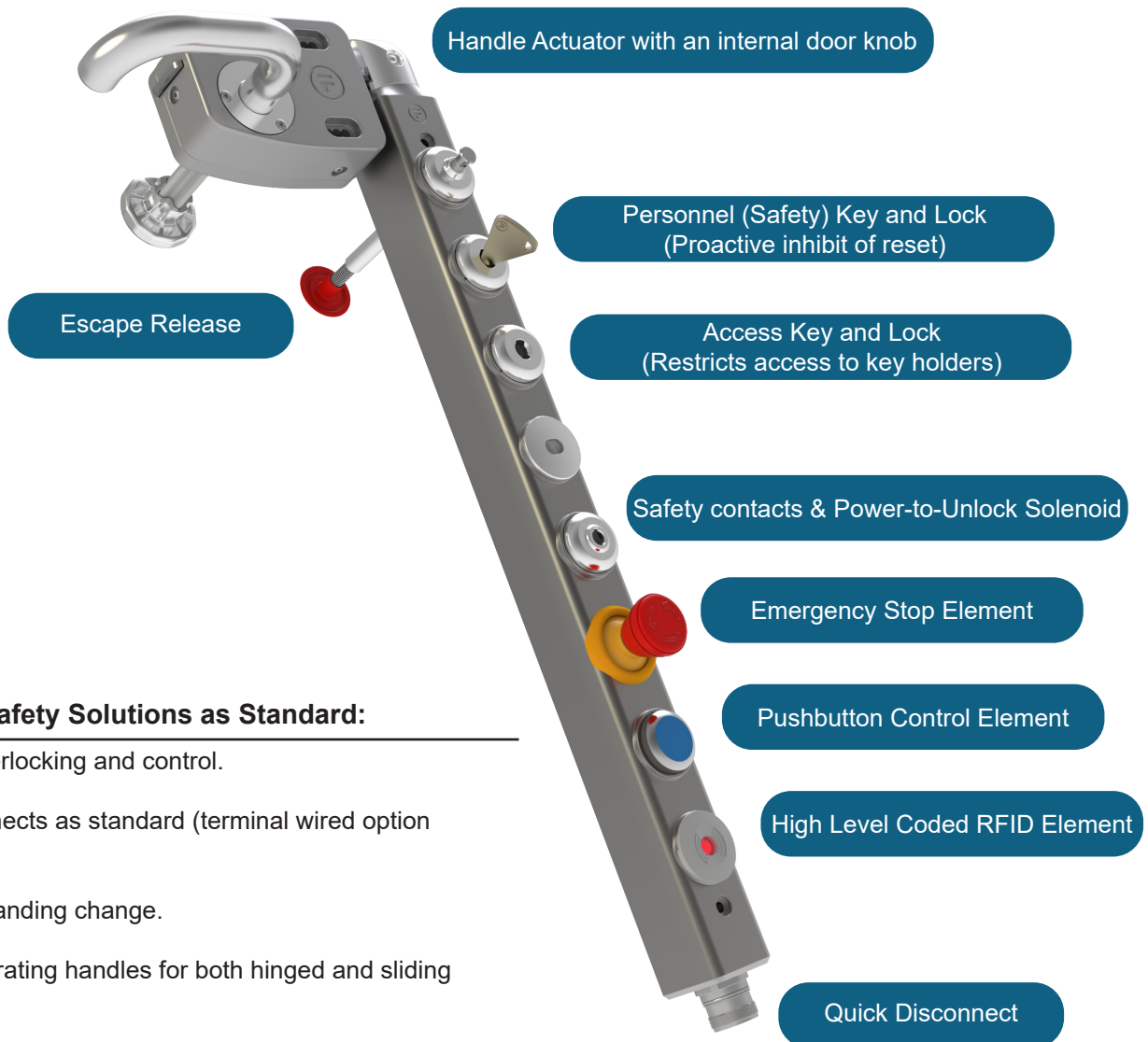

### Customised Safety Solutions as Standard:

- Combines interlocking and control.
- Quick Disconnects as standard (terminal wired option available).
- Fast on-site handing change.
- Choice of operating handles for both hinged and sliding guard doors.
- High Level Coded RFID option.

# Body Transfer Line

## Application Requirement:

Due to the size of the safeguarded space surrounding body transfer lines in an automotive plant, there are blind spots where maintenance personnel could be performing work unknown to a line operator requesting the line to run. This could lead to the line running while maintenance personnel are still working within the cell. To avoid this, access to the transfer line can only be permitted when power has been isolated. Additionally, power cannot be restored until after all personnel have exited the safeguarded space and have returned their keys to the interlock.

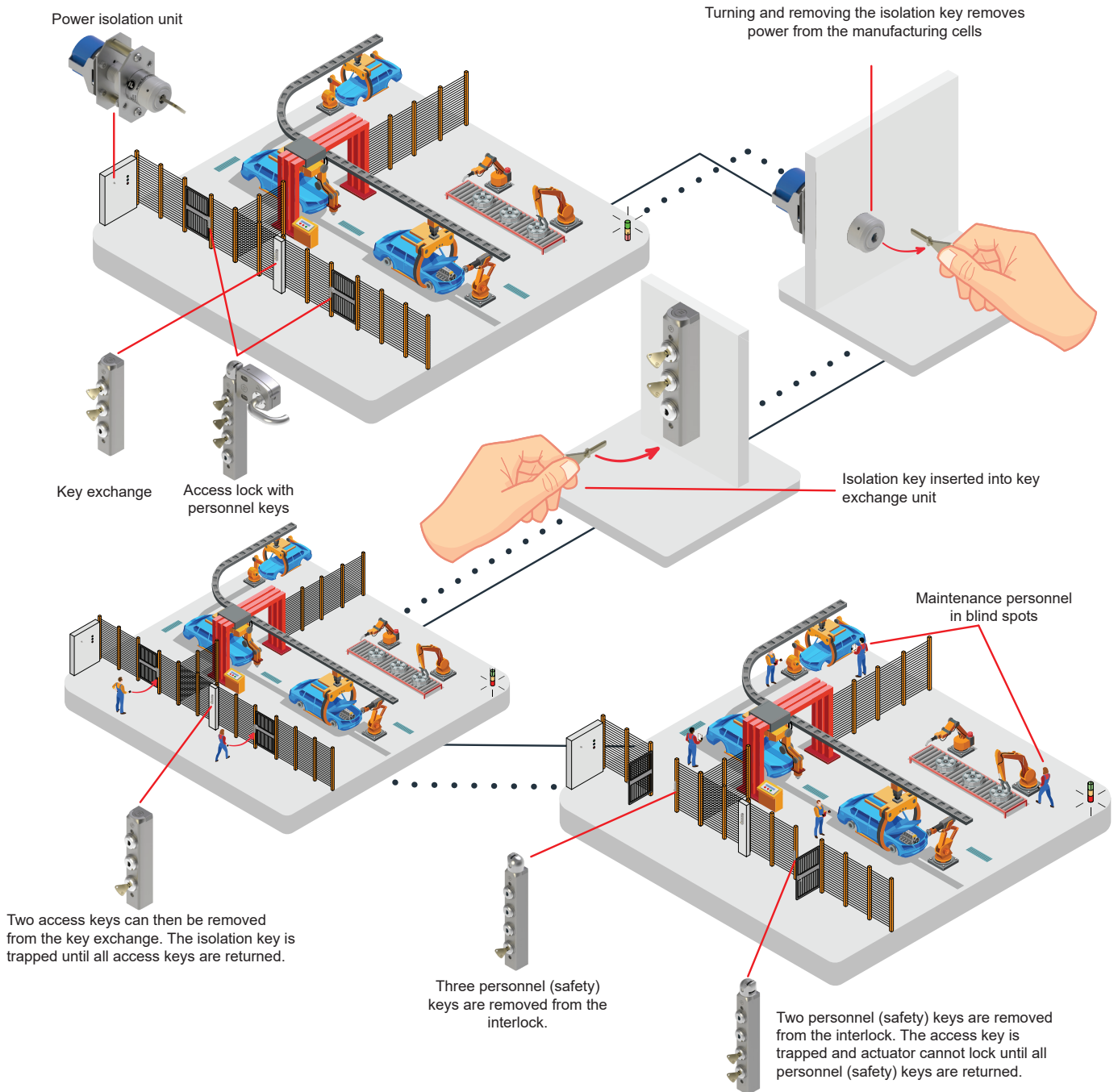
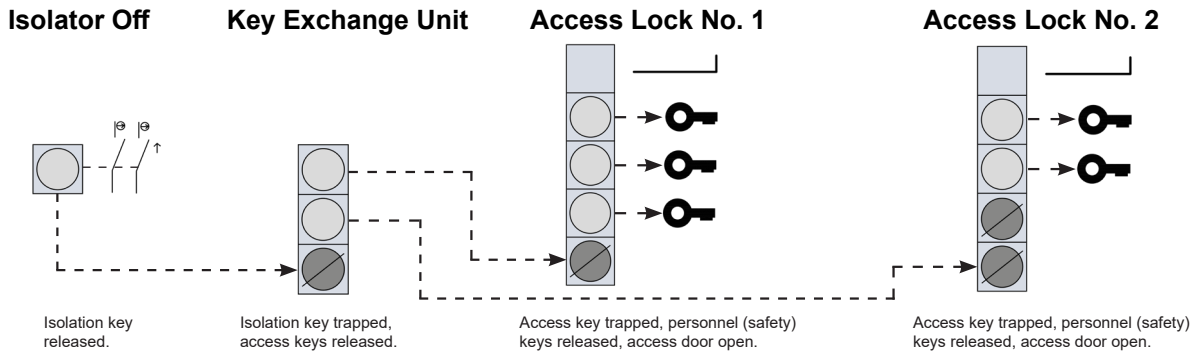

## Application Requirement:

Robots require safeguarding measures during operation and when carrying loads. The robotic palletiser below has two access points and a single central control panel. When the interlock's Power-to-Unlock solenoid is energised and access keys for the access points are released. Mechanical interlocks on the moveable guards can be opened with an access key with each access lock providing a personnel (safety) key for the operator to take inside the cell to prevent restart.

### Power-to-Unlock Solenoid

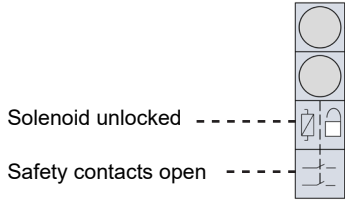

### Access Lock No. 1

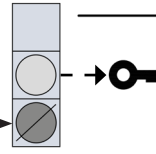

Access keys unlocked, safety contacts open.

Access key trapped, personnel (safety) key released, access door open.

### Access Lock No. 2

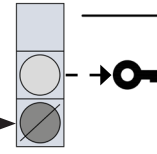

Access key trapped, personnel (safety) key released, access door open.

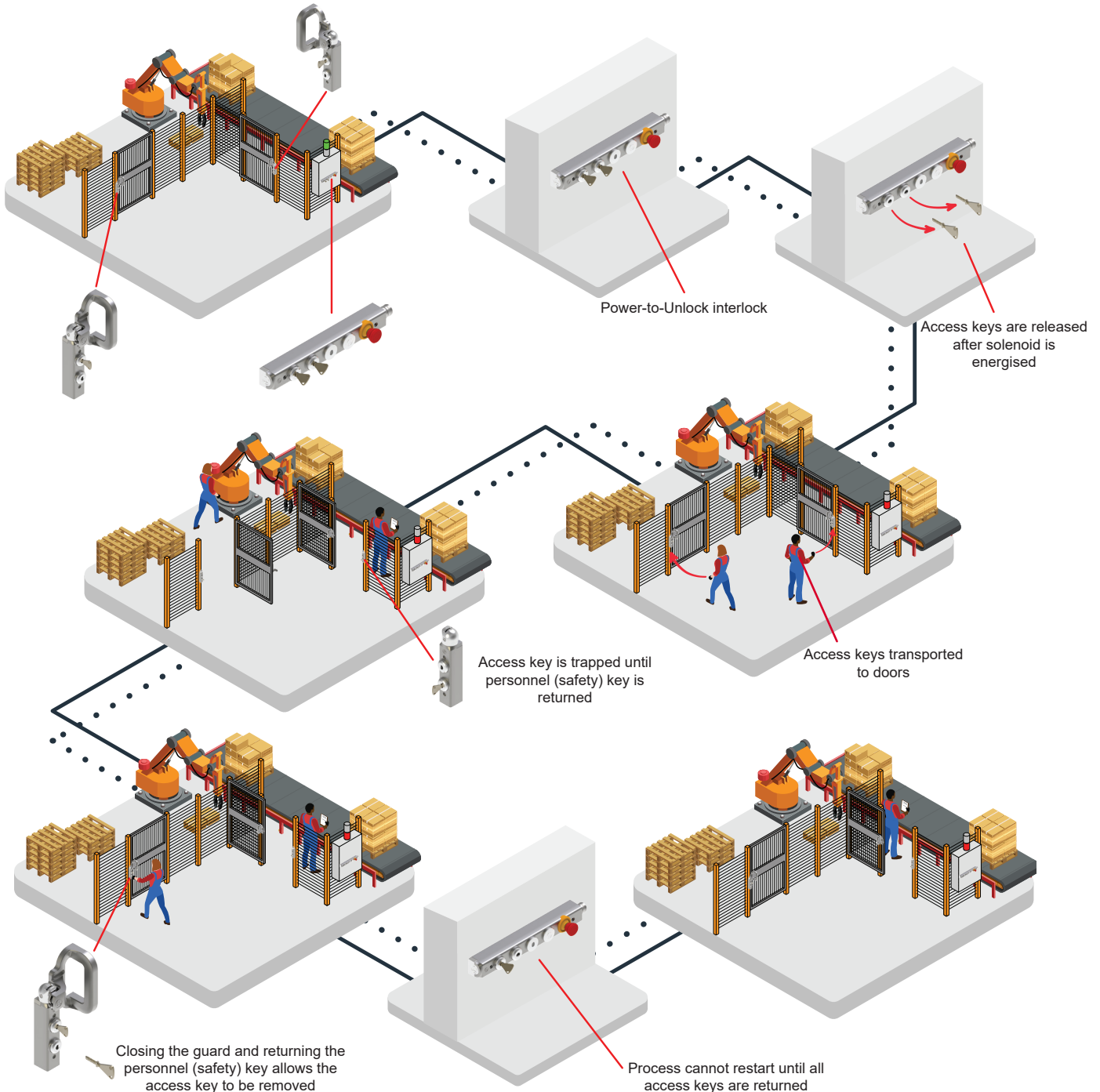

## Application Requirement:

The conveyor system in an automated warehousing application below is safeguarded by interlocked guards. Access is required to remove incorrect packages or clear blockages on the conveyor. The interlock with guard locking keeps the guard locked until the conveyor is stopped. An escape release ensures any operator who becomes trapped within the safeguarded space can exit.

### Interlock with Guard Locking

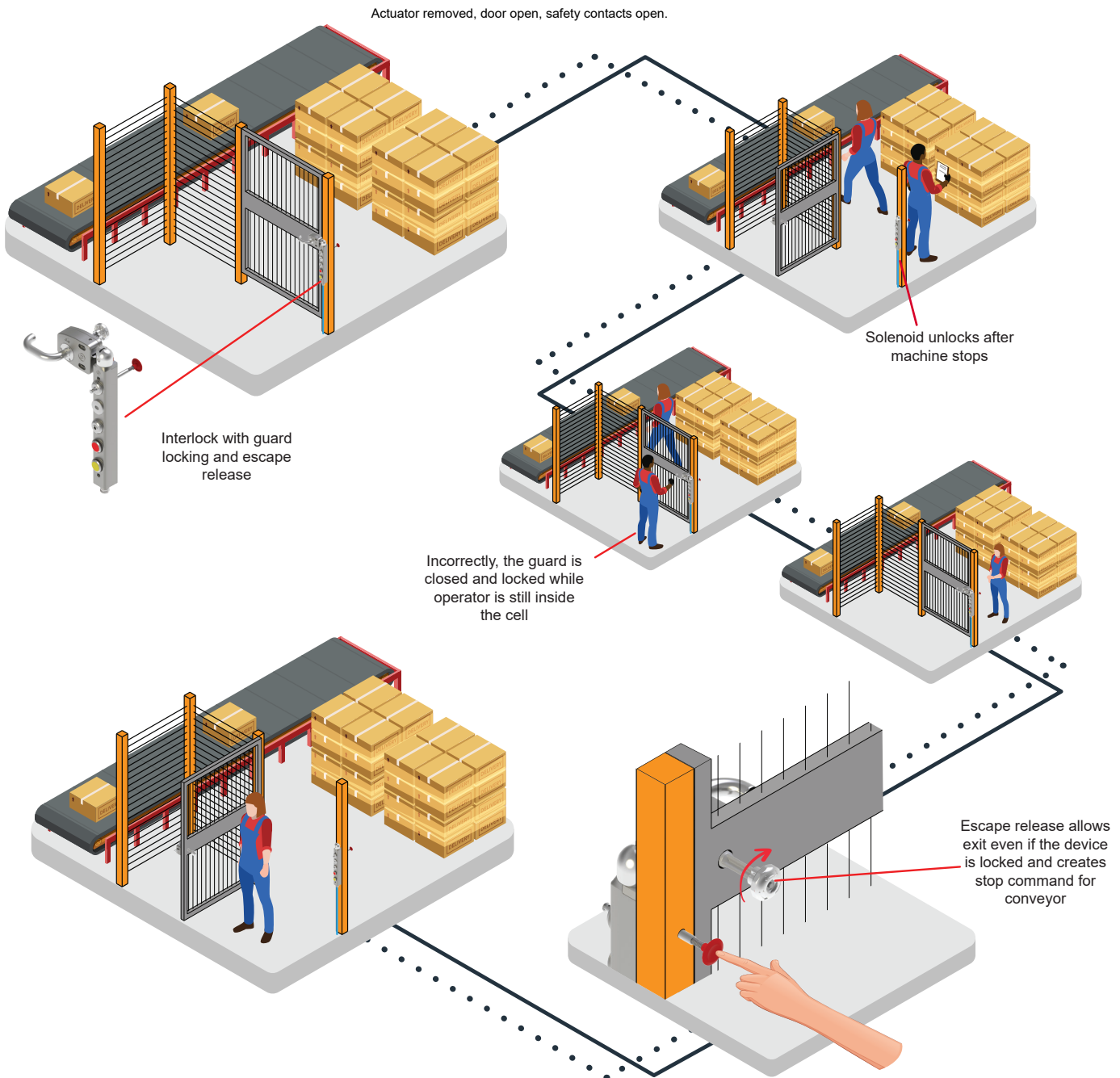
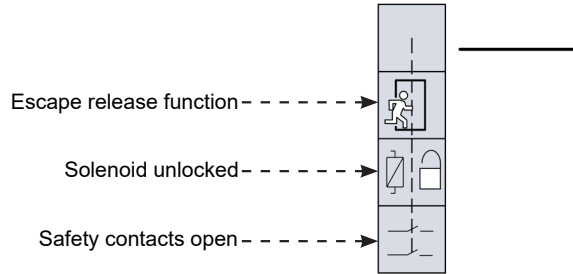

# Common Configurations

## Interlock (Safety Switch)

2NC, 1NO safety contacts.



THESMQ3

## Interlock with High Level Coded RFID and integrated operator controls

Personnel (safety) key available for operator to carry.

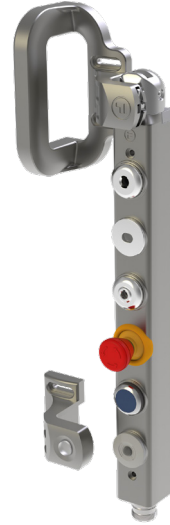

THHSNSMDUEMP6NRQ9

## Interlock with Guard Locking

Power-to-Unlock solenoid with safety contacts.



THFSMDUQM

## Interlock with Trapped Key and operator controls

### controls

Access restricted to key holders, personnel (safety) key available for operator to carry.



THSSNABSMDUEDP6P7P2Q8

## Interlock with Guard Locking and Escape Release

### Release

Power-to-Unlock solenoid with safety contacts. Escape release overrides locking mechanism and creates stop command.



THERXSMDUQM

## Control Station

Control Station with emergency stop, indicator lamp and pushbuttons.



THCETLGP7P3P1Q8

# How to Configure

Configuration tools are available on the Fortress website, [www.fortress-safety.com](http://www.fortress-safety.com)

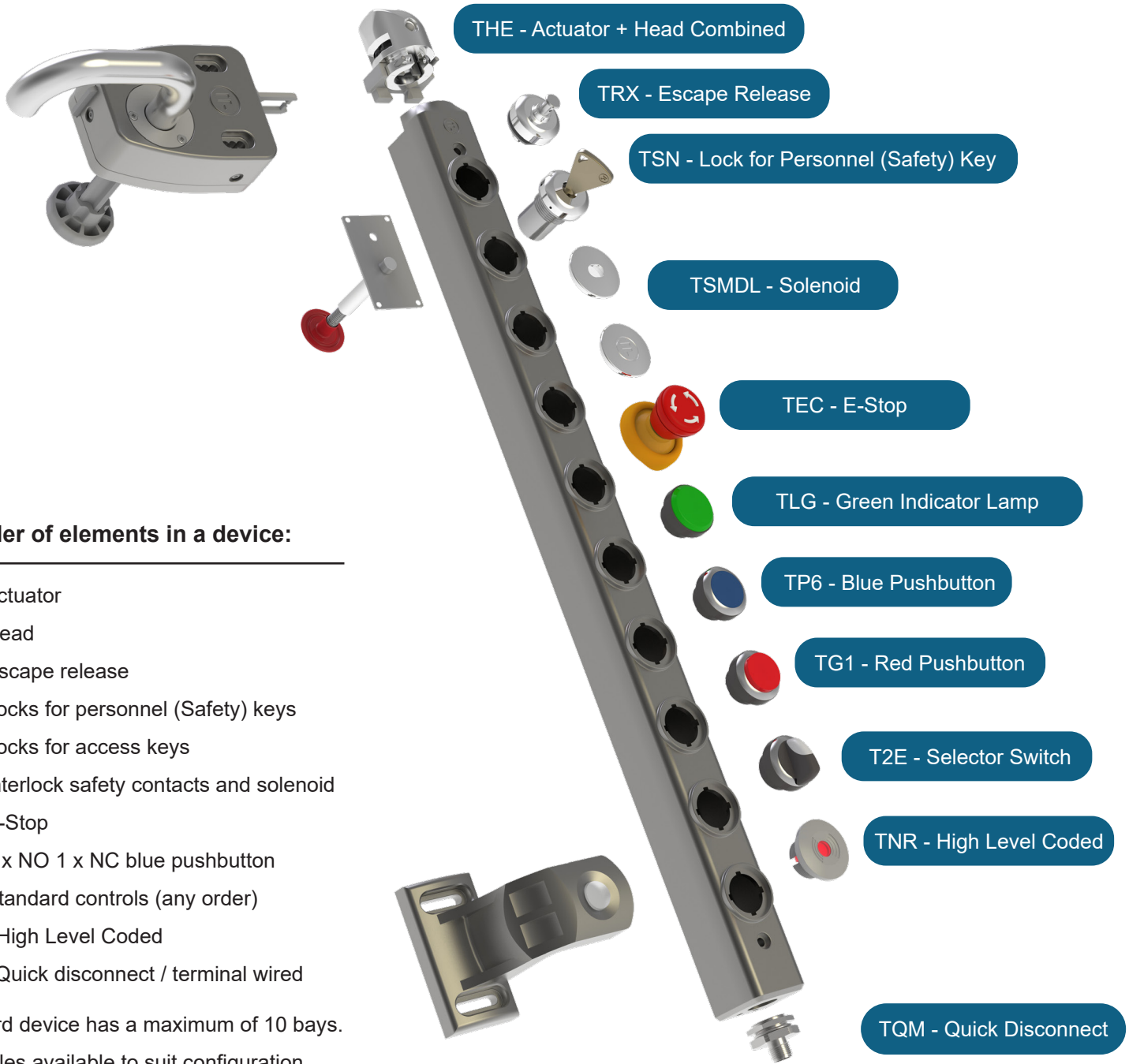

## Configuration Example

At the end of the selection process, the part numbers drop their “T”, except the first item. Example:

THE + TRX + TSN + TSMDL + TEC + TLG + TP6 + TG1 + T2E + TEB + TQM = THERXSN SMDLECLGP6G12ENRQM

When creating a tGard stack, the wiring of connections follow these rules:

1. Safety circuits are in fixed positions on each connector and comprise of volt free circuits for SSR options, or are +24V taken from the supply voltage for OSSD.
2. Inputs / outputs are allocated from the bottom of the stack, ascending.
3. On any one element, the inputs are assigned first, then the output(s).
4. Outputs are +24v, taken from the +24v supply, except for volt free options.
5. Selection of the connector depends upon the wiring requirements for inputs / outputs / safety circuit of the total stack.

## Actuators

Fixed Actuator



Hinged Actuator



Sliding Actuator



High Coded Actuator



Handle Actuator (No Internal knob)



Handle Actuator



## Heads

Cap



Head



## Core Elements

Escape Release



Lock for Personnel (Safety) Keys



Lock for Access Keys



High Level Coded

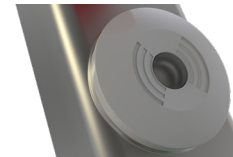

Interlock Safety Contacts & Solenoid Locking

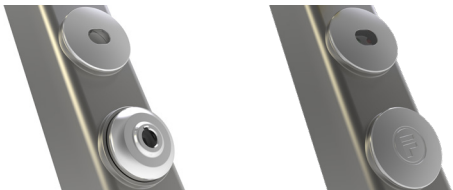

Extension Blank Element



Emergency Stops

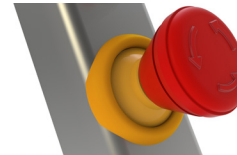

Blue Pushbutton with 1xNO & 1xNC Contacts





# Core Elements

## Indicator Lamps

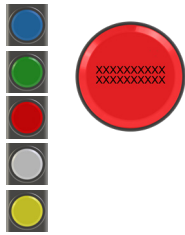

## Pushbuttons

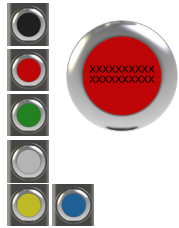

## 2 Position Selector Switch



## 2 Position Selector Key Switch



## Mushroom Pushbutton



## 3 Position Selector Switch



## Illuminating Switches

### Pushbuttons

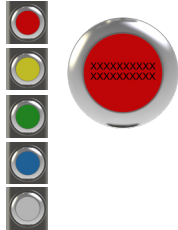

### 2 Position Selector Switch



### 3 Position Selector Switch



# Base Elements

## Safety & Control Quick Disconnect Connectors



Foot



Self Wire



AS- interface



OSSD

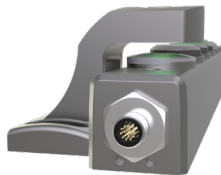

# Keys & Accessories

## Keys

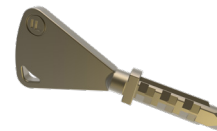

## Padlockable Hasp



Teach Token



Cables



For more information on the padlockable hasp see head & cap element operating instructions.



## Step 1: Actuators



**TAF**  
Fixed Actuator



**TAH**  
Handle Actuator -  
Hinged Door



**TAS**  
Handle Actuator -  
Sliding Door



**TNH**  
High Coded  
Actuator



**TEN**  
Handle Actuator -  
(no internal knob)



**TEH**  
Handle Actuator



All Actuators to be used in combination with a THM head module.



Actuator comes as standard with an High Level Coded RF element



The internal knob on TEH handle does not release the solenoid or lock. A TRX/Z (escape release element) must be used to deliver that functionality.

## Step 2: Head Modules



You can combine an actuator with a head to generate a single part number.

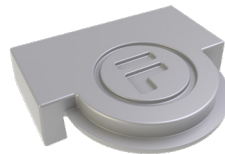

**THC**  
Cap



**THM**  
Head



**THM + TAF = THF**  
Head module including fixed actuator



**THM + TAH = THH**  
Head module including hinged actuator



**THM + TAS = THS**  
Head module including sliding actuator



**THM + TEN = THN**  
Head module including handle actuator (No internal knob)



**THM + TEH = THE**  
Head module including handle actuator

## Step 3: Escape Release

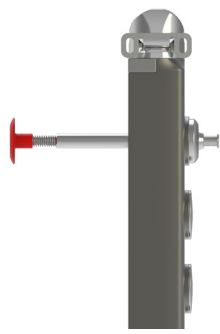

**TRX**  
Standard 60mm  
Escape Release



**TRZ**  
Variable length  
Escape Release

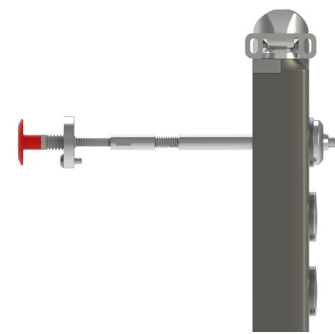

  
Extended  
version available  
(TRZ) - < 300mm.

## Step 4: Personnel (Safety) & Access Lock Element



**TSN**  
Standard Personnel  
(Safety) Lock  
(No Key)\*

**TGN**  
Master Personnel  
(Safety) Lock  
(No Key)\*



**TAB**  
Standard Access  
Lock (No Key)\*

**TQB**  
Master Access  
Lock (No Key)\*

  
\*All keys need  
to be ordered  
separately.

Step 5: Safety Contacts for Interlock Safety Switches

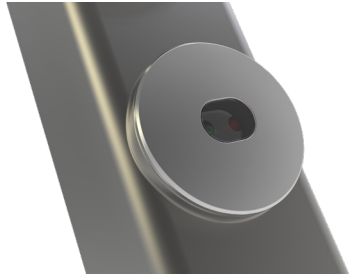

**TSM**  
Safety Contacts

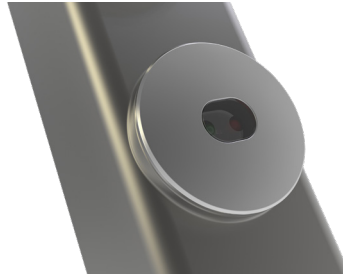

**TSP**  
Safety contacts with extra retention force



**TSS**  
Safety contacts - No N/O monitor contact

Location of safety contacts in stack is first element after all mechanical elements (head, internal release and locks).

Step 6: Safety Contacts for Interlock Safety Switches with Solenoid Controlled Guard Locking

90% of customers select TSMDU.

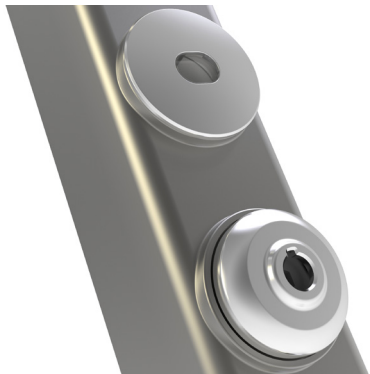

**TSMDU/L**  
Head & solenoid safety contacts in series  
TSMDU (Power-to-Unlock)  
TSMDL (Power-to-Lock)



**TSMEU/L**  
Safety contacts on head element only  
TSMEU (Power-to-Unlock)  
TSMEL (Power-to-Lock)

**TSEEL**  
Safety contacts on head element only (no monitoring contact on head)  
TSEEL (Power-to-Lock)

## Step 7: Extension Blank Element



**TEB**  
Extension Blank  
Element

  
Can be used  
to blank any  
unused bays in a  
configuration

## Step 8: Emergency Stop Element

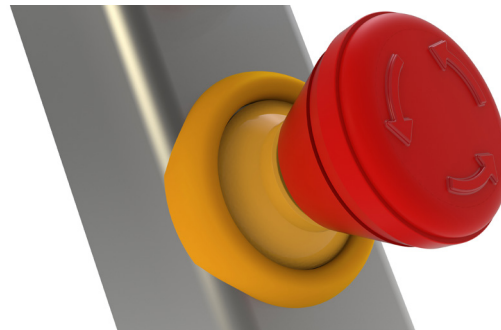

**TEC, TET, TEM, TEP, TEI**  
Emergency stop element, version  
available with a monitoring contact or  
illumination

  
An E-Stop  
is always located  
below any lock or safety  
contact elements. An  
E-Stop is located above any  
control elements, apart from  
TEM & TEI E-Stops which  
are at the bottom of the  
device.

## Step 9: Blue Pushbutton with 1xNO & 1xNC Contacts



**TSR**  
Blue Pushbutton with 1xNO & 1xNC Contacts

**t**  
Location of Blue pushbutton with 1xNO & 1xNC Contacts in stack is highest control element after E-Stop's.

## Step 10: Indicator Lamp Element

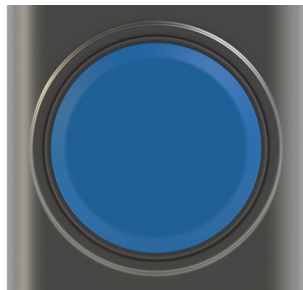

**TLB**  
Indicator Lamp Element - Blue

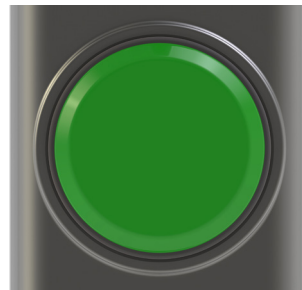

**TLG**  
Indicator Lamp Element - Green

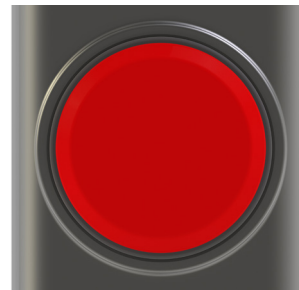

**TLR**  
Indicator Lamp Element - Red



**TLW**  
Indicator Lamp Element - White



**TLY**  
Indicator Lamp Element - Yellow

## Step 11a: Non-Illuminating Switches



**TPB**  
1 N/O Pushbutton -  
Black



**TPR**  
1 N/O Pushbutton -  
Red



**TPG**  
1 N/O Pushbutton -  
Green



**TPW**  
1 N/O Pushbutton -  
White



**TPY**  
1 N/O Pushbutton -  
Yellow

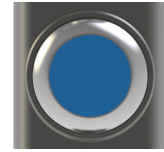

**TPZ**  
1 N/O Pushbutton -  
Blue



**T2A**  
2 Position Selector  
Switch - Latching



**T2V**  
2 Position Selector  
Switch - 1 N/O & 1 N/C



**TK5**  
2 Position Selector Key  
Switch - Latching



**TMB**  
1 N/O Mushroom  
Pushbutton - Black



**T3D**  
3 Position Selector  
Switches - Momentary



**T3H**  
3 Position Selector Switches  
- Momentary/Latching

## Step 11b: Illuminating Switches



**TP1**  
Pushbutton - Red

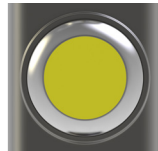

**TP2**  
Pushbutton - Yellow



**TP3**  
Pushbutton - Green

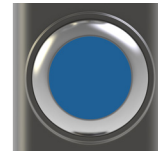

**TP6**  
Pushbutton - Blue



**TP7**  
Pushbutton - White



 Please see operating instructions for a full range of options.

## Step 12: RF Element

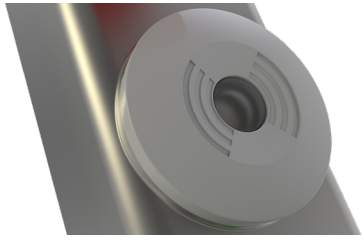

Head (Actuator Locking)

I am daisy chaining my unit to operate in series

No

I want to save on cable costs (less cores in my cables)

No

I am hardwiring my unit

Yes

OSSD with Daisy Chain

Yes

OSSD without Daisy Chain

Yes

SSR

**am**  
Want to save more on your cabling, installation, safety validation and more... Why not check out our Ethernet enabled amGardpro range?

TNC

TNB

TNA



No Head (Non Contact)



TNT

TNS

TNR

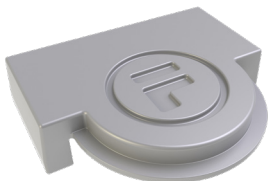



## Step 12a: Safety & Control Connectors

SC = Safety Circuits  
I/O = Inputs / Outputs



5 Pin M12 QD

<b>TQ1</b>	2 SC
------------	------

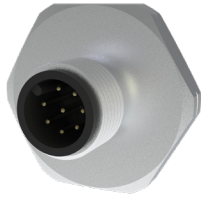

8 Pin M12 QD

<b>TQ2</b>	5 I/O
<b>TQ3</b>	2 SC, 1 I/O
<b>TQG</b>	OSSD, 2 SC, 3 I/O



12 Pin M12 QD

<b>TQL</b>	9 I/O
<b>TQM</b>	2 SC, 5 I/O
<b>TQO</b>	OSSD, 2 SC, 7 I/O



12 Pin M23 QD

<b>TQ4</b>	9 SC
<b>TQ5</b>	2 SC, 5 I/O
<b>TQH</b>	OSSD, 2 SC, 7 I/O

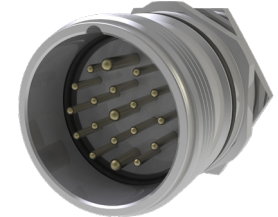

19 Pin M23 QD

<b>TQ8</b>	2 SC, 12 I/O
<b>TQ9</b>	4 SC, 8 I/O
<b>TQJ</b>	OSSD, 2 SC, 14 I/O
<b>TQQ</b>	OSSD, 4 SC, 10 I/O

## Step 12b: Foot, Self Wire Connectors, AS-interface



**TBF**  
Foot Element

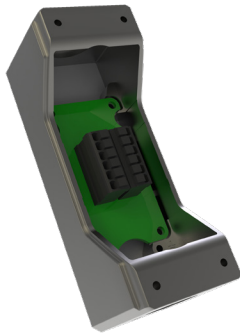

12 Terminals

<b>TW1</b>	2 SC, 6 I/O
<b>TW7</b>	OSSD, 2 SC, 8 I/O

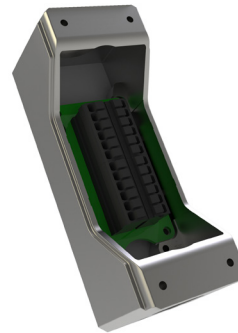

24 Terminals

<b>TW3</b>	4 SC, 14 I/O
<b>TW8</b>	OSSD, 4 SC, 16 I/O

**TW4**  
24 Terminals

<b>TW4</b>	6 SC, 10 I/O
<b>TW9</b>	OSSD, 6 SC, 12 I/O



**TEBB4**  
Up to 2 AS-i nodes



**TEBB8**  
Up to 4 AS-i nodes

## Step 14: Keys

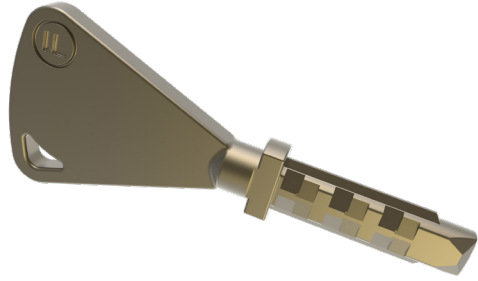

**TKS**  
Standard Key

**TKM**  
Master Key

## Step 15: Accessories



**TLO**  
Padlockable Hasp

Allows interlock blocking of tGuard device. Padlocks / hasps lock the interlock open.



**TNX**  
Teach Token for High Level Coded RF Element

**CABLE - M - TQ**

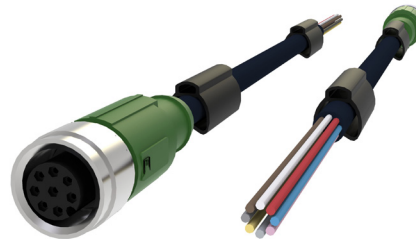

Cable Length (m)

- 2
- 5
- 10
- 20

Safety & Control Connector

1	2	L	4	8
	3	M	5	9
	G	O	H	J
				Q





# FORTRESS

## FORTRESS

“ We have the peace of mind that our workers are safe and protected by Fortress equipment. ”



## FORTRESS

“ Fortress’ best quality is providing each customer the most robust and safe solution - all while being completely customizable and retaining a high level of quality. ”



## FORTRESS

“ Fortress is best at providing customised solutions at a rapid turnaround - reacting immensely to a challenge to put the customer’s needs first. ”



## FORTRESS

“ We value suppliers that can help navigate the standards and provide guidance that is directly linked to our applications. ”



## Fortress Global Offices and Manufacturing Facilities

[www.fortress-safety.com](http://www.fortress-safety.com)

### Fortress Interlocks Ltd

+44 (0)1902 349000

### Fortress Interlocks Pty Ltd

+61 (0)3 9771 5350

### Fortress Interlocks Europe

+31 (0)10 7536060

### Fortress Interlocks China

+86 (021) 6167 9002

### Fortress Interlocks USA

+1 (859) 578 2390

### Fortress Interlocks India

+91 7042358818

Contact us



## Notes

Blank area for notes.