

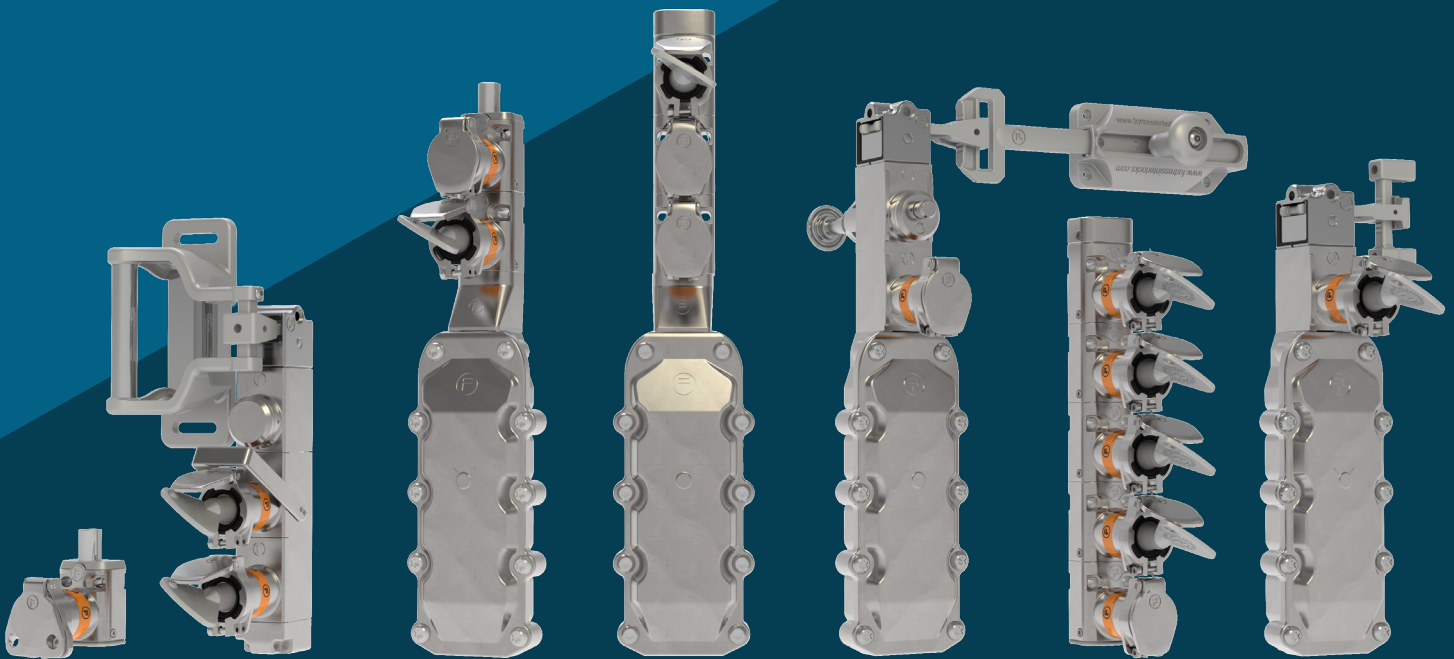

# FORTRESS



## Interlocks for Hazardous Locations & Explosive Atmospheres



THE QUEEN'S AWARDS  
FOR ENTERPRISE:  
INTERNATIONAL TRADE  
2018



# Alfred



# Machinery Safety in Explosive Atmospheres and Hazardous Locations

## What is Alfred?

In hazardous locations and explosive atmospheres, installing incorrectly certified equipment can lead to devastating losses; financially through loss of production and damage to facilities to the most extreme cases, where incidents lead to injured personnel or even loss of life.

Alfred is a safeguarding solution which combines machinery safety with protection against explosive atmospheres to keep operators and businesses safe.

The Alfred solution provides mechanical and electromechanical interlocks, or a combination of both for volatile environments, and hazardous locations.

Access to machinery is critical for productivity, however machinery can be dangerous if not correctly guarded.

Processes creating combustible dust as a by-product can pose an explosion risk without correctly certified safeguarding solutions.

Alfred solutions can guarantee safe access and explosion prevention.

## Who are Fortress?

Fortress are safety experts who design and manufacture customised safety equipment, protecting people working in hazardous workplaces. We educate and offer tailored safety solutions which are reliable and extremely durable, guaranteeing minimal downtime while always keeping your people as safe as possible.

## Who is Alfred?

Our inspiration for the range is Alfred Nobel, a world-renowned chemist and inventor, his most famed creation being that of dynamite in 1867. Alfred was appalled to see how his invention was used in military operations. To heal a damaged legacy, he dedicated his fortune to the Nobel Prize, an institution which has since inspired multiple generations. The Nobel Peace Prize most notably celebrates those who have sought peace and resultantly saved countless lives across the world.



Through our Alfred range, we intend to save lives by providing the best safety solutions.

## Why Choose Alfred?

### Highly Customisable

Contact our team to discuss and design your unique Alfred solution



### Proactive Inhibit Functions

Protect from unexpected restart with safety keys



### Robust

Stainless steel manufacture with a retention force of 7kN



### Reliable

Third party certified to guarantee the highest level of safety and product longevity



### Maximise Productivity

Designed to enable efficient access with installation local to processes



# How Can I Build My Safeguarding Solution?

1.

What type of risk assessment are you using for your product?

Zonal Risk Assessment

Divisional Risk Assessment

Other

Why do I need a Risk Assessment?

See page 4-5 to learn more

See page 6-7 to learn more

A risk assessment helps to map the levels of exposure to the hazardous by-products of processes. The closer the proximity, the higher the exposure, and the greater the ignition risk. This information helps us best advise you on your safety solution.

2.

Where in the hazardous location are you installing your safeguarding device(s)?

A.

The **entire solution** within any part of **Zone 1 / 21 or 2 / 22**

The **entire solution** within **Division 2**

An area where **exposure to the hazardous substance is occasional**



B.

A combination of **Zone 0 / 20, & Zone 1 / 21**

A combination of **Division 1 & Division 2**

An area where **exposure to the hazardous substance is more frequent**

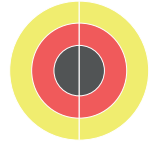

C.

Must be **Zone 0 / 20 only**

Must be **Division 1 only**

An area where **exposure to the hazardous substance is constant**



D.

Outside these areas or none of the above? Contact our team and we can support you in designing your safety solution.



3.

What are you trying to achieve with your system 'inside' the hazardous location or ex atmosphere?

A **Mechanical Solution**

See our mechanical-only solution on page 8

**Monitor an Action**

Check out the 'monitor' application on page 9

Enforce **Run-Down** through Solenoid Control

Check out the 'control' application on page 9

**Combined Sequential System**

Check out the 'sequential system' on page 10

A.



B.

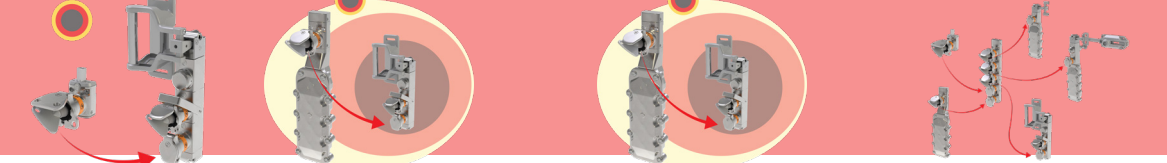

C.





### Locality of Ex Environment

How close to the operation which is creating combustible or flammable products is your product being placed?

The area surrounding an ex environment can be split into zones which relate to the proximity to the ex combustible / flammable by-product creation and the frequency of exposure to these by-products.

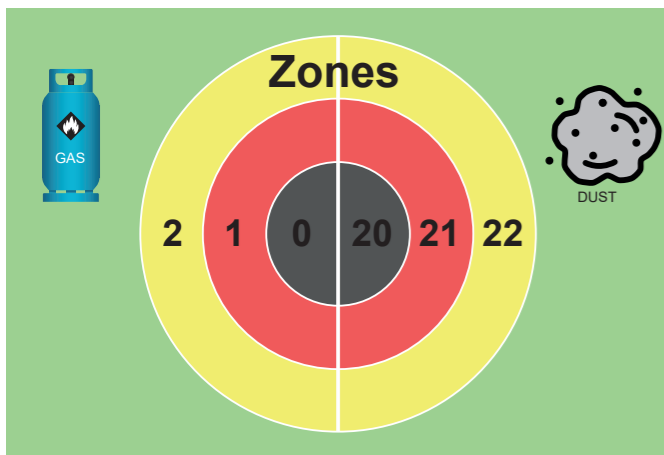

**0 / 20** Constant / continuous exposure explosive atmosphere is continuously present during normal operation. Alfred mechanical solutions can allow access in Zones 0 / 20, sequential systems can be used to achieve monitoring and controlled access into and out of Zone 0 / 20.

**1 / 21** Occasional exposure explosive atmosphere is occasionally present during normal operation. Alfred can be located within this region defined as Zone 1 (**Gas**), Zone 21 (**Dust**). Category 2.

**2 / 22** Low frequency exposure explosive atmosphere is not likely to occur in normal operation but could occur. As this is a lower risk area than Zone 1/21, Alfred can also be located within this region, defined as Zone 2 (**Gas**), Zone 22 (**Dust**).

**0 / 20** Zero exposure explosive atmosphere will never occur in normal operation. In this locality there is no risk of explosion, and no consideration for Ex protection is required, thus any interlock can be used.

### Temperature Considerations

- Environmental operating temperature
- Maximum permissible surface temperature
- Ignition temperature of combustible **Dust** / ignitable **Gas**

#### Temperature Considerations

Temperature classification, refers to the **maximum surface temperature** a device in this location can reach.

Some combustible dusts and ignitable gases have a low ignition temperature. If the surface temperature of a device in this location surpasses the lowest ignition temperature of the **gas** or **dust** an explosion could occur.

Thus the lower the maximum surface temperature of the device, the better!

**T6** – can be used with any hazard which will not ignite at temperatures below **85°C** (Alfred is suitable for use in this environment according to IECEx and ATEX).

Alfred can be used with all ignitable temperatures above those listed (i.e T5, T4, T3, T2, T1 in addition to T6).



**Environment** – this will affect how the device can operate in normal conditions.

**Product Surface** – when in this environment, what is the maximum surface temperature the product can reach?



**Flammable / Combustible Substance** – what is the minimum temperature that will cause this to ignite?

Temperature classification, maximum permissible surface temperature (Gas or dust ignition temp must be higher)

NEC 505 CEC 18 ATEX / IECEx	Max Surface Temp
T1	450°C (842°F)
T2	300°C (572°F)
	280°C (536°F)
	260°C (500°F)
	230°C (446°F)
	215°C (419°F)
T3	200°C (392°F)
	180°C (356°F)
	165°C (329°F)
T4	135°C (275°F)
	120°C (248°F)
T5	100°C (212°F)
<b>T6</b>	<b>85°C (185°F)</b>

Ambient temperature (tamb); or operating temperature refers to the thermal conditions a device operates under in normal circumstances.

The tamb for Alfred is between **-20°C** and **+60°C**.

**Equipment Group (ATEX)**  
**Group I - Underground Mines**  
Let's look at the mechanical access solutions!



**Group II - Surface Industry**  
(Alfred can be used in any application up to the specified Ex ratings)

ATEX (UK and Europe Only)			All Regions with IECEx Basis (not including North America)							
II	2	G	Ex	db	h	IIC	T6	Gb	IP67	Tamb -20°C to +60°C
		D		tb		IIIC		Db		
Locality of Ex Environment			Hazardous by-product		Protection Concept		Hazardous by-product		Surface Temp	

### Type of By-Product

Combustible **Dust** or Flammable **Gas** – what type of product is being created? By-products created by processes can come under two categories; flammable **gases** and combustible **dust**.

#### Type of By-product

**Flammable Gas (G)**  
A substance of matter with no fixed shape which is explosive when mixed with oxygen and an ignition source.

Gas Group (gas group defined II) - certain gases are more volatile than others. Acetylene and hydrogen sit within the highest risk category. The IIC certification within the Alfred range ensures safe use with these most volatile gases

Gas Group (ATEX/IECEx)	Typical Substances
IIC	Acetylene – highest achievable (Alfred)
IIC	Hydrogen
IIB	Ethylene
IIA	Propane

#### Protection Level

- Ga/Da** – Exposed continuously to Ex atmosphere (Alfred mechanical solutions only)
- Gb/Db** – Exposed occasionally – high protection (Alfred)
- Gc/Dc** – Exposed rarely – enhanced protection (Alfred)

**Note:** Alfred equipment continues to perform after one fault.



**Combustible Dust (D)**  
Solid material composed of distinct particles or pieces, regardless of size, shape, or chemical composition, which presents a fire or deflagration hazard when presented a source of ignition.

Dust Group (dust group defined III) - dust particles come in varying levels of combustibility. IIIC refers to the most conductive of dust types and the Alfred range is certified for safe use within these environments.

Dust Group (ATEX/IECEx)	Typical Substances
IIIC	Conductive – highest achievable (Alfred)
IIIB	Non-conductive dust
IIIA	Combustible Flyings

### Protection Concept

**Particulate Ingress** – What size of particulate is the product exposed to in any possible operation.



**Moisture Ingress** – What exposure does the product have to moisture sources during operation, cleaning, servicing or under any other potential circumstance. **Maximum dust protection 6.**

**Flammable Protection** – How protective is the enclosure against flammable gases in case of ignition.



**Ingress Protection** - The Alfred range has been tested and certified up to IP67 & IP69 to provide the highest level of moisture and solid contaminant protection.

### Electro-Mechanical Solutions

What does 'h' mean? In electro-mechanical products, mechanical components are also tested to ensure they pose no risk of ignition; this includes actuators, heads, lock modules, and escape releases.

### Protection Type

**db** – flameproof enclosure; explosions are contained within the device case in case of internal ignition (re. IEC EN CAS UL 60079-1)

**tb** – dustproof enclosure; protected against all dust ingress and tested to ensure dust build up on surface does not cause ignition of combustibles in maximum temperature conditions (IEC EN 800079-37; IEC EN 800079-38)

### Protection Concept

Ex environments don't only pose an explosive risk with ignition sources, their by-products and the processes surrounding them can pose additional challenges such as ingress of moisture, and particulate ingress.

Ingress Protection (IP)			
Dust protection		Water protection	
0	No protection	0	No protection
1	>50mm	1	Vertical drip
2	>12.5mm	2	Angled drip
3	>2.5mm	3	Spray
4	>1.0mm	4	Splash
5	Dust-protected	5	Jet
6	<b>Dust-tight</b>	6	Powerful jet
		7	<b>Temporary immersion</b>
		8	Immersion
		9	<b>Powerful high temp water jets</b>





# North American Ex Product Rating Guide

## Locality of Ex Environment

In North America, the equivalent to Zone 2 / 22 is Division 2, and Zone 0 / 20 / 1 / 21 are combined into Division 1.

Alfred solutions with electromechanical components are suitable for up to Division 2 only. Mechanical only products can also be used within Division 1.

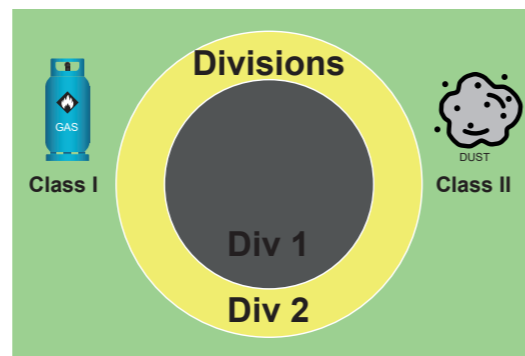

## Equipment Categories

<b>Class I</b> – Flammable gases, vapours or liquids.	<b>Division 1</b> – Where ignitable concentrations are likely under normal operation conditions. <b>Alfred mechanical units only.</b>	<b>Group A</b> Acetylene <b>Group B</b> Hydrogen <b>Group C</b> Ethylene <b>Group D</b> Propane
	<b>Division 2</b> – Where ignitable concentrations are not likely to exist under normal operating conditions.	
<b>Class II</b> – Combustible dust.	<b>Division 1</b> – Where ignitable concentrations are likely under normal operation conditions. <b>Alfred mechanical units only.</b>	<b>Group F</b> Coal Dust <b>Group G</b> Grain Dust
	<b>Division 2</b> – Where ignitable concentrations are not likely to exist under normal operating conditions.	
<b>Class III</b> – Ignitable fibres and flyings.	<b>Division 1</b> – Where ignitable concentrations are likely under normal operation conditions. <b>Alfred mechanical units only.</b>	
	<b>Division 2</b> – Where ignitable concentrations are not likely to exist under normal operating conditions.	

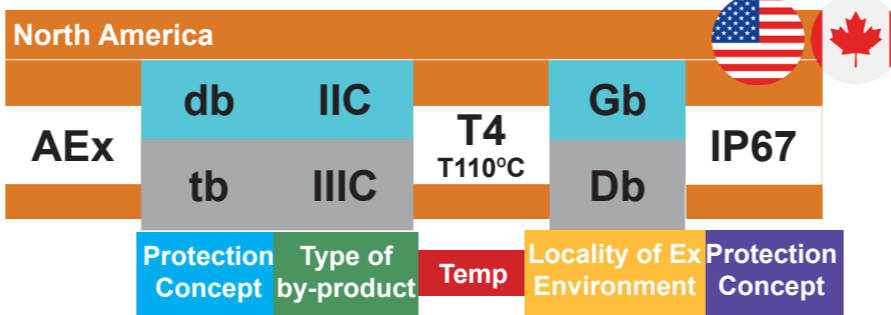

## Temperature Considerations

- Environmental operating temperature
- Maximum permissible surface temperature
- Ignition temperature of combustible **Dust** / ignitable **Gas**

## Temperature Considerations

Temperature Classification, refers to the **maximum surface temperature** a device in this location can reach.

Some combustible dusts and ignitable gases have a low ignition temperature. If the surface temperature of a device in this location surpasses the lowest ignition temperature of the **gas** or **dust** an explosion could occur.

Thus the lower the maximum surface temperature of the device, the better!

**T4** – can be used with any hazard which will not ignite at temperatures below **135°C** (Alfred is suitable for use in this environment according to North American Certification).

Alfred can be used with all ignitable temperatures above those listed (i.e T3, T2, T1 in addition to T4).



**Environment** – this will affect how the device can operate in normal conditions?

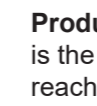

**Product Surface** – when in this environment, what is the maximum surface temperature the product can reach?



**Flammable / Combustible Substance** – what is the minimum temperature that will cause this to ignite?

Temperature classification, maximum permissible surface temperature (Gas or dust ignition temp must be higher)	
NEC 500 CEC Annex J	Max Surface Temp
T1	450°C (842°F)
T2	300°C (572°F)
T2A	280°C (536°F)
T2B	260°C (500°F)
T2C	230°C (446°F)
T2D	215°C (419°F)
T3	200°C (392°F)
T3A	180°C (356°F)
T3B	165°C (329°F)
<b>T4</b>	<b>135°C (275°F)</b>
T4A	120°C (248°F)
T5	100°C (212°F)
T6	85°C (185°F)

Ambient temperature (tamb); or operating temperature refers to the thermal conditions a device operates under in normal circumstances.

The tamb for Alfred is between **-20°C and +60°C**.

## Type of By-Product

Combustible **Dust** or Flammable **Gas** – what type of product is being created? By-products created by processes can come under two categories; flammable **gases** and combustible **dust**.

## Type of By-product

**Flammable Gas (G)**  
A substance of matter with no fixed shape which is explosive when mixed with oxygen and an ignition source.

Gas Group (gas group defined II) - certain gases are more volatile than others. Acetylene and hydrogen sit within the highest risk category. The IIC certification within the Alfred range ensures safe use with these most volatile gases.

## Protection Level

- Ga/Da** – Exposed continuously to Ex atmosphere (Alfred mechanical solutions only)
- Gb / Db** – Exposed occasionally – High protection (Alfred)
- Gc / Dc** – Exposed rarely – Enhanced protection (Alfred)

**Note:** Alfred equipment continues to perform after one fault.



## Combustible Dust (D)

Solid material composed of distinct particles or pieces, regardless of size, shape, or chemical composition, which presents a fire or deflagration hazard when presented a source of ignition.

Dust Group (dust group defined III) - dust particles come in varying levels of combustibility. IIIC refers to the most conductive of dust types and the Alfred range is certified for safe use within these environments.

Typical Substances	North American Division
Acetylene – highest achievable (Alfred)	Class I, Group A (Alfred)
Hydrogen	Class I, Group B
Ethylene	Class I, Group C
Propane	Class I, Group D

Typical Substances	North American Division
Conductive – highest achievable (Alfred)	Class II Group E (Alfred)
Non-conductive dust	Class II, Group F/G
Combustible Flyings	Class III

## Protection Concept

**Particulate Ingress** – What size of particulate is the product exposed to in any possible operation.



**Moisture Ingress** – What exposure does the product have to moisture sources during operation, cleaning, servicing or under any other potential circumstance. **Maximum dust protection 6.**

**Flammable Protection** – How protective is the enclosure against flammable gases in case of ignition.



**Ingress Protection** - The Alfred range has been tested and certified up to IP67 & IP69 to provide the highest level of moisture and solid contaminant protection.

## Protection Type

**db** – flameproof enclosure; explosions are contained within the device case in case of internal ignition (re. IEC EN CAS UL 60079-1)

**tb** – dustproof enclosure; protected against all dust ingress and tested to ensure dust build up on surface does not cause ignition of combustibles in maximum temperature conditions (IEC EN 800079-37; IEC EN 800079-38)

## Protection Concept

Ex environments don't only pose an explosive risk with ignition sources, their by-products and the processes surrounding them can pose additional challenges such as ingress of moisture, and particulate ingress.

Ingress Protection (IP)			
Dust protection		Water protection	
0	No protection	0	No protection
1	>50mm	1	Vertical drip
2	>12.5mm	2	Angled drip
3	>2.5mm	3	Spray
4	>1.0mm	4	Splash
5	Dust-protected	5	Jet
6	<b>Dust-tight</b>	6	Powerful jet
		7	<b>Temporary immersion</b>
		8	Continuous immersion
		9	<b>Powerful high temp water jets</b>



# Selecting the Alfred Solution For You

## Mechanical Only Solutions

To keep all electrical wiring outside the explosive atmosphere and hazardous location or when installing safeguarding devices into Zone 0, Zone 20, or Division 1, you will need a mechanical only solution.

Trapped key systems eliminate most of the wiring associated with other types of interlocks by using keys to control power and access in sequence.

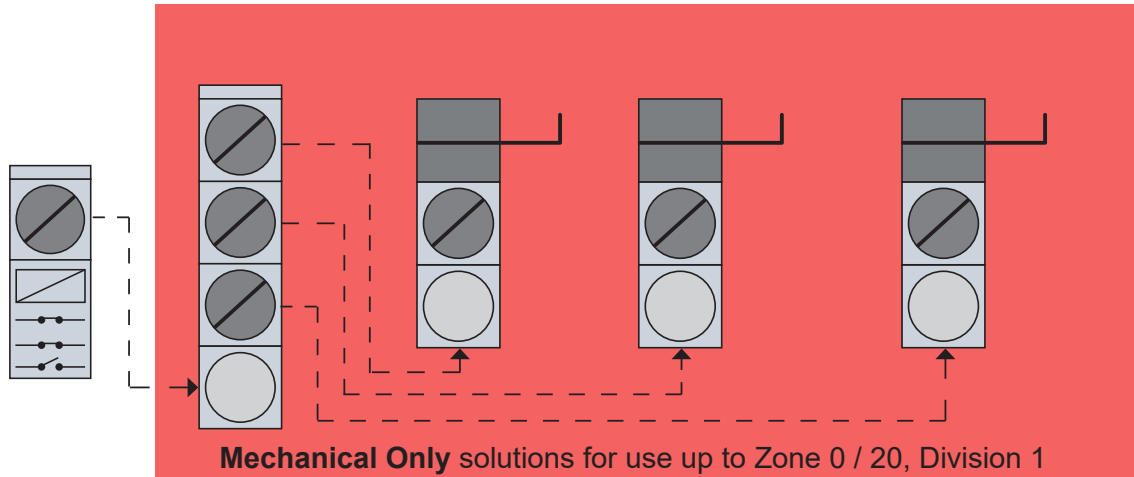

In the example system below, all electrical wiring is kept outside of Zone 2 / 22 or Division 2 (North America) and access is achieved by the release of a solenoid-controlled key shown on the left-hand side of the image, which is inserted into a key exchange, and used to enter the guard through the product shown on the right-hand side.

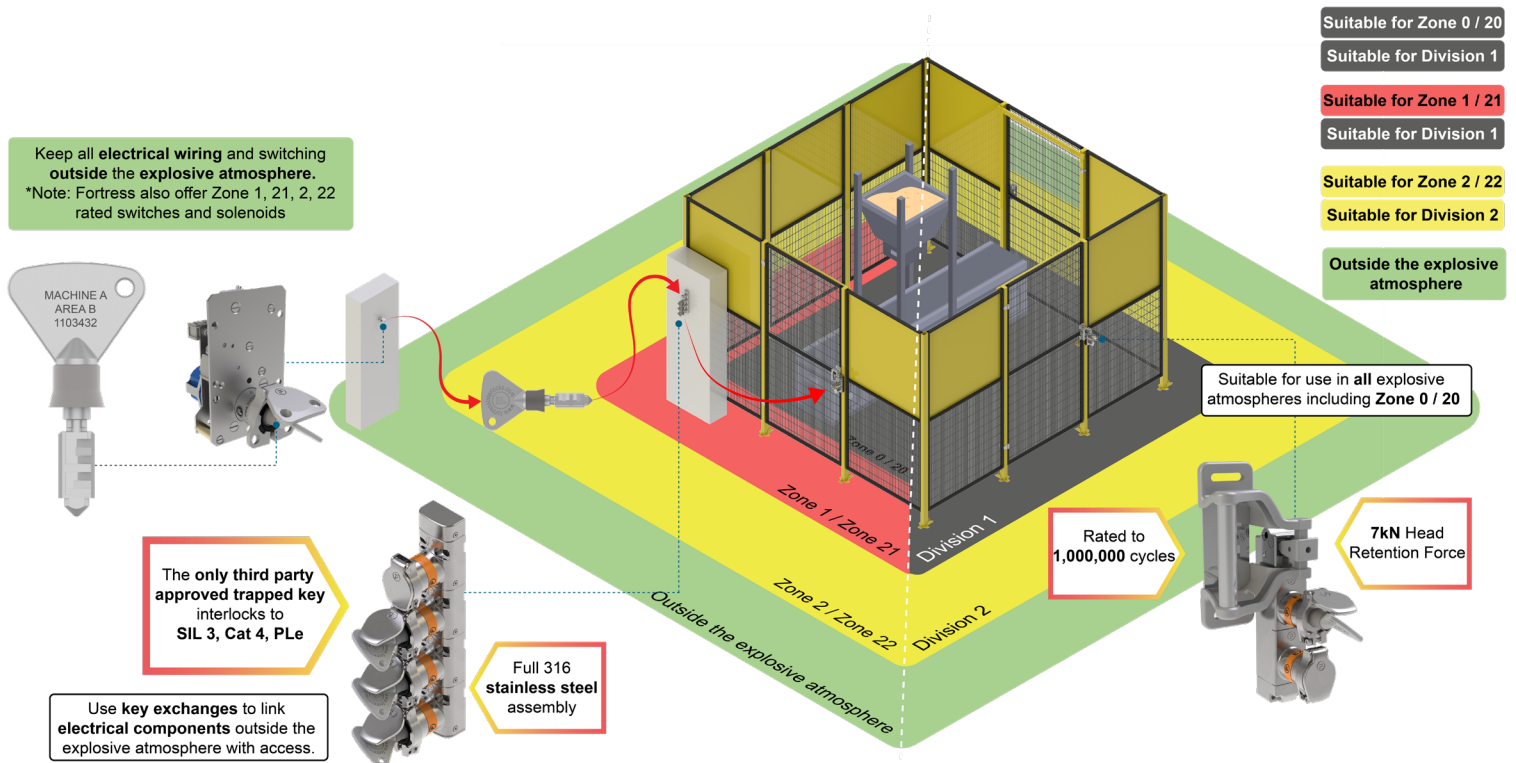

# Selecting the Alfred Solution For You

## Electromechanical Solutions in Hazardous Locations or Ex Atmospheres

Maximising uptime is crucial for productivity. Solenoid locking interlocks and non-locking interlocks with or without trapped keys can be installed for fast and frequent access to the equipment. Controlled access and power isolation solutions within the Alfred range have been certified for use up to Zone 1, 21, or Division 2 (North America Only).

In the example below, two access points are guarded by two different devices:

- On the left of the image, a guard lock ensures a run-down time is completed within the cell before access can be granted. The solenoid-controlled lock can be 'unlocked' allowing the guard to be opened.
- On the right side of the image, a safety switch with trapped key adapters monitors the access. An access key needs to be presented to gain access. A safety key carried by the operator prevents restart of equipment. If an operator does become trapped within the safeguarded space, an escape release will override the key mechanism to provide escape.

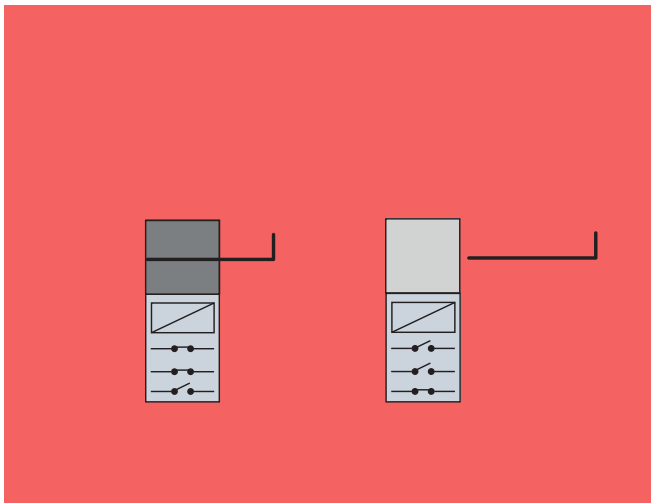
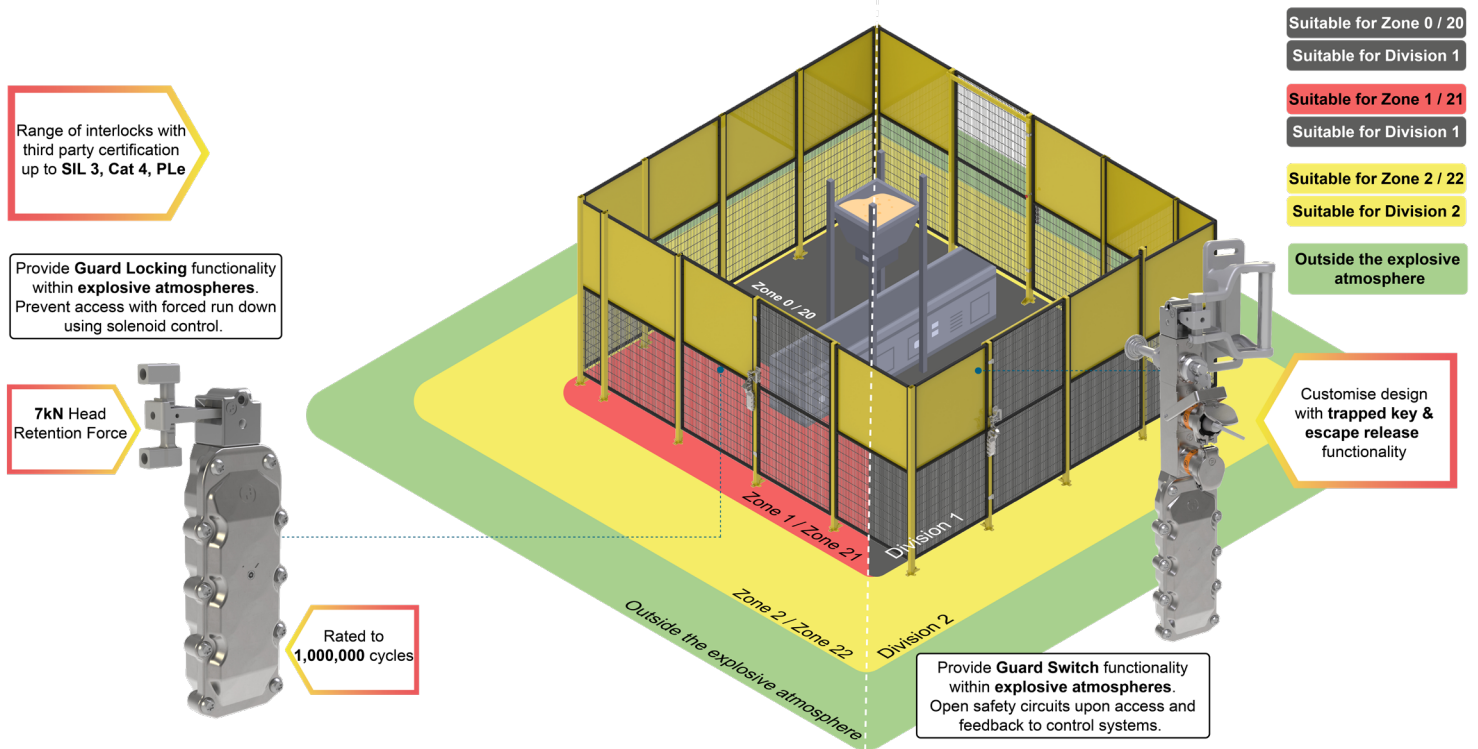

Electromechanical solutions with solenoid control for use up to Zone 1 / 21 or Division 2

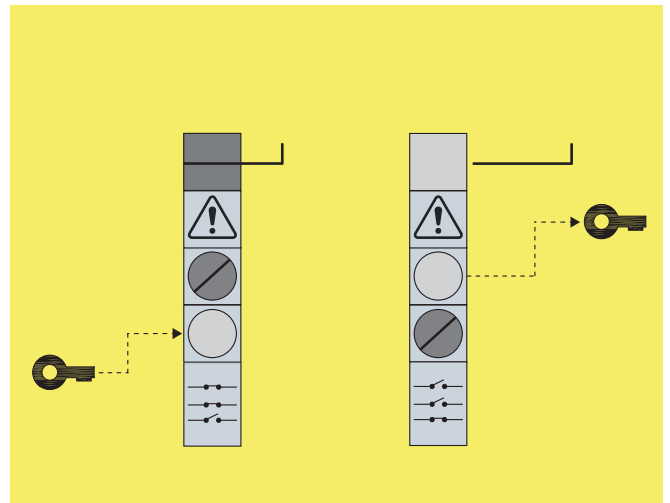

Electromechanical solutions with monitoring switch for use up to Zone 1 / 21 or Division 2

# Selecting the Alfred Solution For You

## Sequential Systems for Hazardous Environments

Sequential systems ensure processes such as electrical isolation, fluid power isolation and access are controlled in a specific order.

In this system, access cannot be permitted until an exchange of keys from two sources of power (fluid and electrical) release a set of keys which permit entry to various entryways in the safeguarding. Electrical components in this system can all operate up to Zone 1 / 21 or Division 2, whilst mechanical only components can safely operate up to Zone 0 / 20 & Division 1.

Fluid power valves can be isolated with a trapped key bolt module to release a key, while key switches are used to isolate the electrical power to the system. Sequential design prevents access until both sources are isolated.

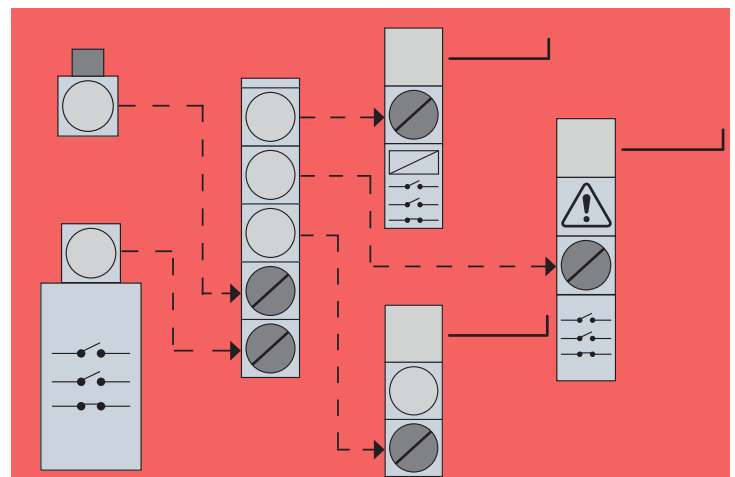
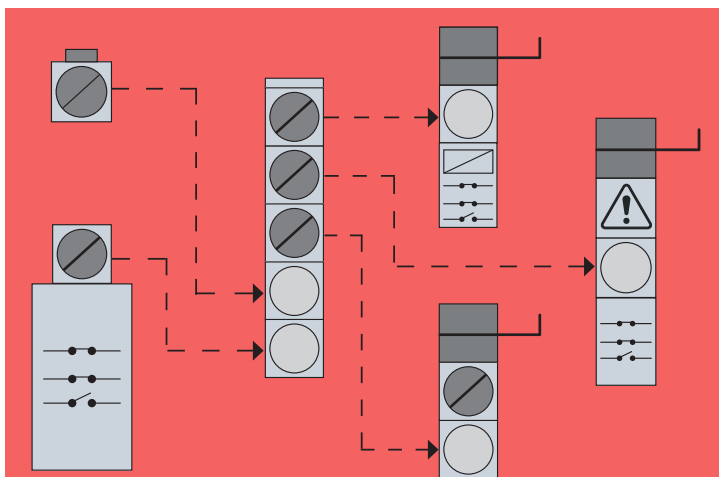
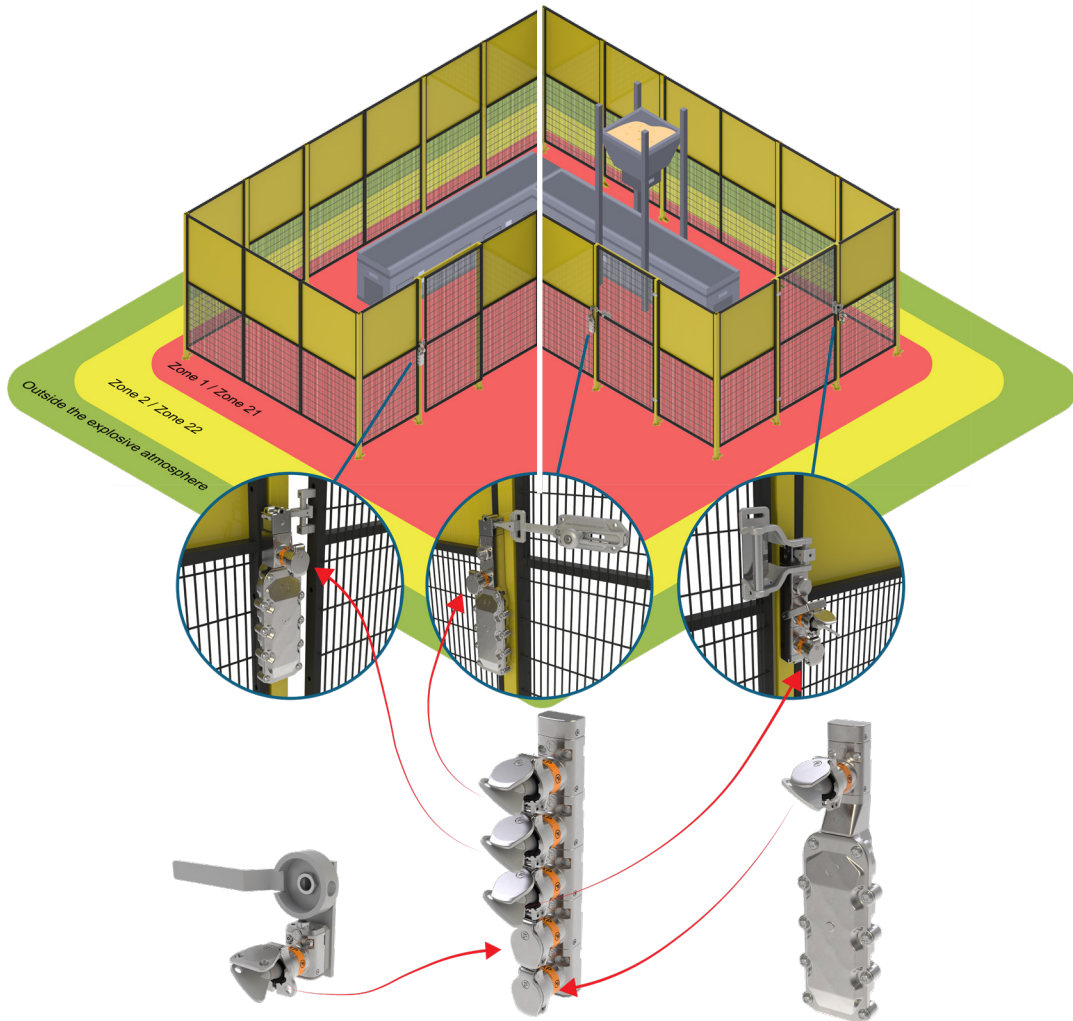

Sequential systems can allow access from Zones 1 / 21 or Division 2 into Zones 0 / 20 or Division 1.



# Sequencing Information on Alfred Systems

## Trapped Key Terminology

Trapped key part numbers describe their units in the reference state we call the “Normal State”, which means the following will be true:

- Switches will be in their described state, i.e. “Normally Closed” or “Normally Open”
- Any keys used as personnel keys will be inserted in a lock.

Locks are split into two groups, which are described in the part number as shown below:

- Normally In Locks (NIL) have keys inserted in the Normal State



- Normally Out Locks (NOL) do not have keys inserted in the Normal State

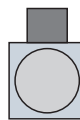

For a typical machine guarding system, the system will be described with all units in their Normal State (i.e. machine running). For more complicated systems, the system might be described with some units in their Normal state, and others in their Opposite State. Similarly, the process to convert a system in its normal state to the system in its opposite state will result in steps where parts of the system are in Normal State, parts are in Opposite State.

## Definitions

Partially sequential; the lock at the top of a group of locks (NIL or NOL) must be inserted and rotated first, follow by the rest in any order

Non-sequential; locks within a group (NIL or NOL) can be trapped or removed in any order

Sequential; locks within a group (NIL or NOL) must be inserted and rotated in order of their position, with the top of the group inserted first.

- Z NIL Partially sequential, NOL Partially sequential
- Y NIL Non-sequential, NOL Non-sequential
- W NIL Partially sequential, NOL Non-sequential

## Standard Sequence

Z - EXPBMS mechanical only, and switch monitored

Y - EXPXMS mechanical only

W - EXPXMS...-XT4.. switch monitored key exchange sequences which include only Normally In Locks will have a standard 'W' sequence.

Sequence Letter	Lock Type closest to Top / Head / Bolt / Cap	Normally In Locks Sequence	Normally Out Locks Sequence	XT401 Switch State Change
Z	Normally In	Partially Sequential	Partially Sequential	Key turned in top Normally Out lock
Y	Normally In	Non-Sequential	Non-Sequential	Key turned in bottom lock of unit
W	Normally In	Partially Sequential	Non-Sequential	Key turned in bottom lock of unit

Throughout the following configuration pages we distinguish the zonal and divisional areas to which our Alfred units are suitable for using the below diagrams. For clarification on zones and divisions please refer to pages 4-7.

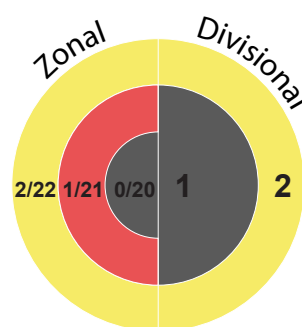
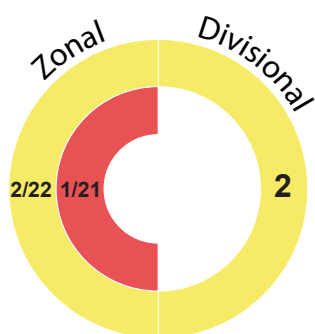

# Guard Locks and Guard Switches with up to Three Key Modules

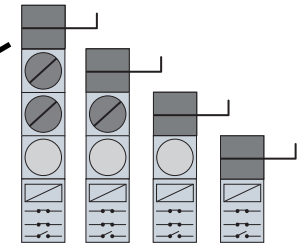

Head	Part No.
Standard head	S6
Head module with lockout hasp	S8

Actuator	Part No.
Fixed tongue	TA
Slidebar	TN
Slidebar with return spring	TS
Fixed handle	HL
No actuator	NO

Handing	Part No.
Front entry	1
Left entry	2
Rear entry	3
Right entry	4

Gap Filler	Part No.
Gap filler	GF

You will require a gap filler if handing '1' is required with an 'EKL' and no escape release is selected.

Lock Types	Part No.
Standard lock with standard dustcover	2
Standard lock with Padlockable dustcover	3
Masterable lock with standard dustcover	7
Masterable lock with padlockable dustcover	8

Guard Locking			Part No.
Power-to-Unlock, safety-on-guard locking	L	4	11
Power-to-Unlock, safety-on-guard			16
Power-to-Lock, safety-on-guard			61
Power-to-Lock, Full safety-on-guard locking			71

Guard Switch	Part No.
Guard switching	T401

Maximum three key modules total (including extracted, safety and access)

If you select T401 your part number is now complete

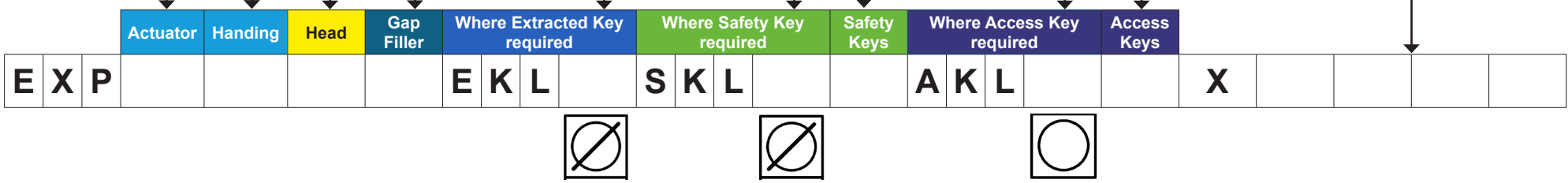

# Guard Switch With Escape Release with up to Three Key Modules

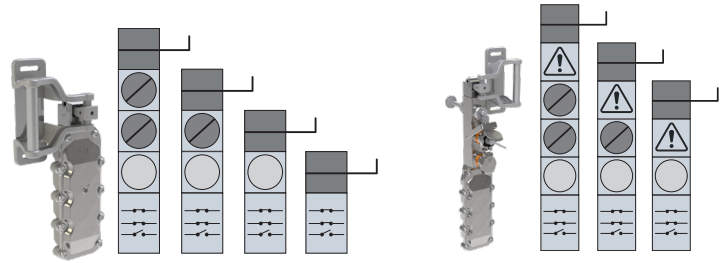
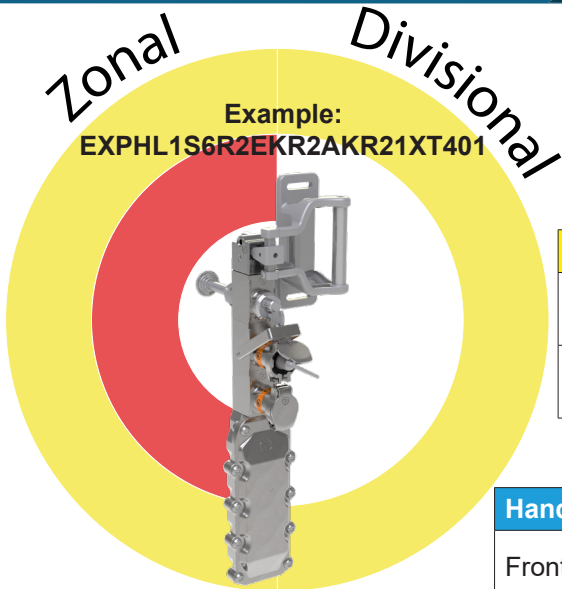

Head	Part No.
Standard head	S6
Head module with lockout hasp	S8

Handing	Part No.
Front entry	1
Left entry	2
Rear entry	3
Right entry	4

Escape Release	Part No.
60mm from rear of unit to ER actuator key reset	R2
Variable length from rear of unit to ER actuator key reset	R4
60mm from rear of unit to ER actuator key less reset	RX
Variable length from rear of unit to ER actuator key less reset	RZ

Lock Types	Part No.
Standard lock with standard dustcover	2
Standard lock with padlockable dustcover	3
Masterable lock with standard dustcover	7
Masterable lock with padlockable dustcover	8

Actuator	Part No.
Fixed tongue	TA
Slidebar with internal lever	TI
Slidebar with internal lever and non latching external handle	TF
Fixed handle	HL
No actuator	NO

Maximum three key modules total (including extracted, safety and access)

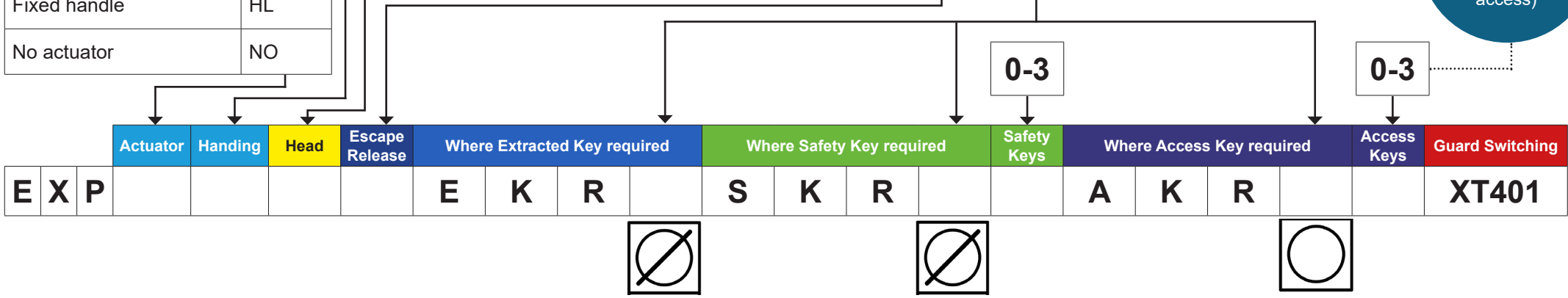

# Mechanical Guard Interlock With Up To Three Key Modules

Zonal  
 Divisional  
 Example:  
**EXPTN2S6SAKL22FT0**

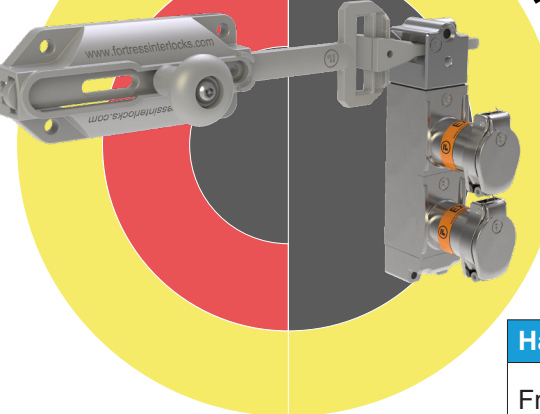

Head	Part No.
Standard head	S6
Head module with lockout hasp	S8

Handing	Part No.
Front entry	1
Left entry	2
Rear entry	3
Right entry	4

Actuator	Part No.
Fixed tongue	TA
Slidebar	TN
Slidebar with return spring	TS
Fixed handle	HL
No actuator	NO

Lock Types	Part No.
Standard lock with standard dustcover	2
Standard lock with Padlockable dustcover	3
Masterable lock with standard dustcover	7
Masterable lock with padlockable dustcover	8



Gap Filler	Part No.
Gap filler	GF

You will require a gap filler if handing '1' is required with an 'EKL' and no escape release is selected.

Maximum three key modules total (including extracted, safety and access)

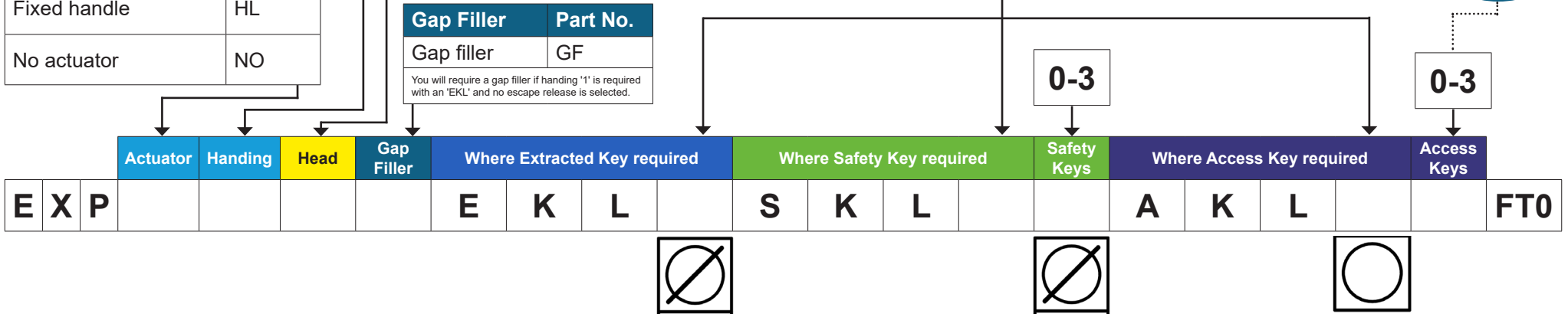

# Mechanical Key Exchange

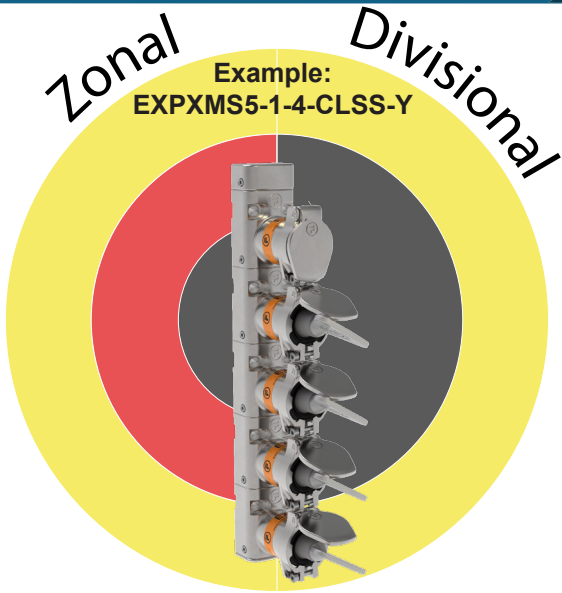

EXPXMS5-1-4-CLSS  
(Normal)  
Standard Sequence

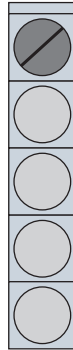

EXPXMS5-1-4-CLSS  
(Opposite)  
Standard Sequence



Description	Part No.
Number of Locks with Key(s) free in normal state (NOL)*	1 - 5

Description	Part No.
Number of Locks with Key(s) inserted in normal state (NIL)*	1 - 5

Description	Part No.
Total quantity of locks	1 - 5

\*See page 11 for terminology.

Description	Part No.
Standard CL lock	C
Master ML lock	M

Description	Part No.
Standard dustcover	S
Padlockable dustcover	L



E X P X M S - - - L S - Y

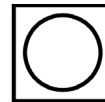

The Y sequence is defined on page 11. For alternative sequencing, speak to our team.

# Mechanical Key Exchange with Solenoid Control / Monitoring Switch

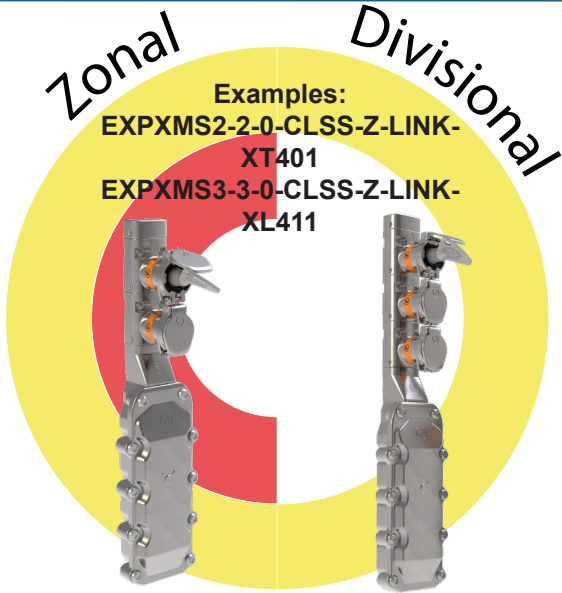

EXPBMS3-2-1...Z-LINK-XT401 (Normal)  
Standard Sequence

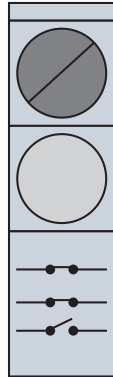

EXPBMS3-2-1...Z-LINK-XT401 (Opposite)  
Standard Sequence

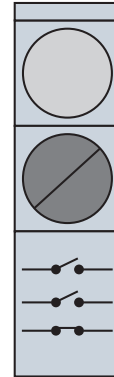

Solenoid Locking Safety Switch			Part No.
L	4	Power-to-Unlock, full safety-on-guard locking	11
		Power-to-Unlock, full safety-on-guard switching	16
		Power-to-Lock, safety-on-guard Switching	61
		Power-to-Lock, full safety-on-guard locking	71

Description	Part No.
Number of Locks with Key(s) free in normal state (NOL)*	1 - 5

Description	Part No.
Number of Locks with Key(s) inserted in normal state (NIL)*	1 - 5

Description	Part No.
Total quantity of locks	1 - 5

\*See page 11 for terminology.

Description	Part No.
Standard dustcover	S
Padlockable dustcover	L



Description	Part No.
Standard CL lock	C
Master ML lock	M

Safety Switch	Part No.
Guard switching	T401

If you select T401 your part number is now complete

E X P X M S - - - L S - Z - LINK - X

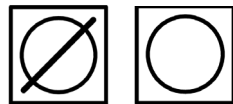

The Z sequence is defined on page 11. For alternative sequencing, speak to our team.

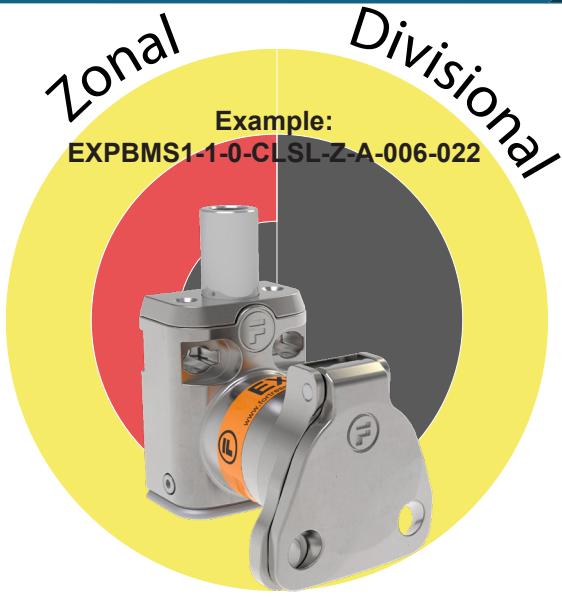

**EXPBMS1-1-0-...A**  
(Normal)  
Standard Sequence

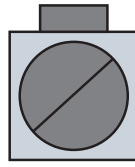

**EXPBMS1-1-0-...A**  
(Opposite)  
Standard Sequence

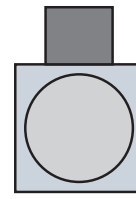

Description	Part No.
Standard dustcover	S
Padlockable dustcover	L



Description	Part No.
Bolt withdrawn/retracted in normal state. (All NIL with keys inserted, all NOL with keys free)	A
Bolt shot/extended in normal state. (All NIL with keys inserted, all NOL with keys free)	D

Description	Part No.
Number of Locks with Key(s) free in normal state (NOL)*	1 - 5

Description	Part No.
Number of Locks with Key(s) inserted in normal state (NIL)*	1 - 5

Description	Part No.
Total quantity of locks	1 - 5

Description	Part No.
Standard CL lock	C
Master ML lock	M

\*See page 11 for terminology.



**006 - 022**

**Bolt Retracted - Bolt Shot**

**E X P B M S - - - L S - Z - - XXX - XXX**

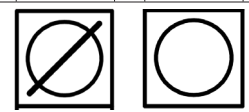

The Z sequence is defined on page 11. For alternative sequencing, speak to our team.

Alternative bolt lengths are available, speak to our team for more information

# Mechanical Bolt Module with Monitoring Switch

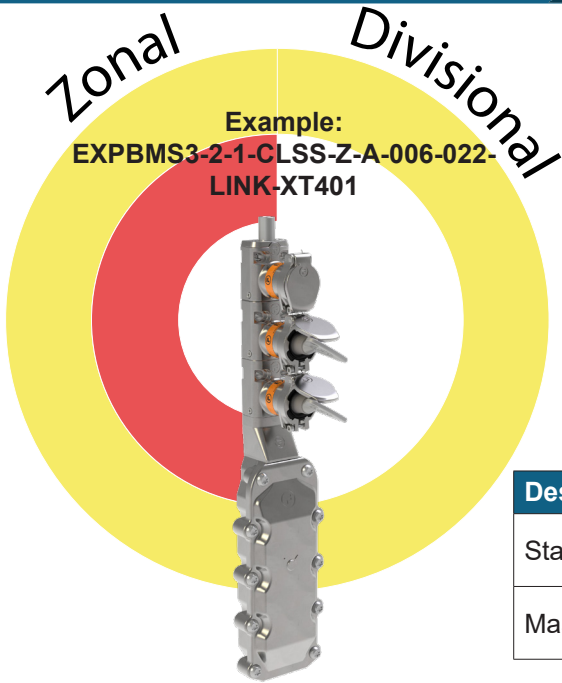

Description	Part No.
Standard dustcover	S
Padlock-able dustcover	L



Description	Part No.
Standard CL lock	C
Master ML lock	M

Description	Part No.
Bolt withdrawn/retracted in normal state. (All NIL with keys inserted, all NOL with keys free)	A
Bolt shot/extended in normal state. (All NIL with keys inserted, all NOL with keys free)	D



Description	Part No.
Number of Locks with Key(s) free in normal state (NOL)*	1 - 5

Description	Part No.
Number of Locks with Key(s) inserted in normal state (NIL)*	1 - 5

Description	Part No.
Total quantity of locks	1 - 5

\*See page 11 for terminology.

006 - 022

Bolt Retracted - Bolt Shot

Alternative bolt lengths are available, speak to our team for more information

**E X P B M S - - - L S - Z - - XXX - XXX - LINK - XT401**

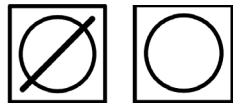

The Z sequence is defined on page 11. For alternative sequencing, speak to our team.





# FORTRESS

## FORTRESS

“

We have the peace of mind that our workers are safe and protected by fortress equipment.

”



## FORTRESS

“

Fortress is best at providing customised solutions at a rapid turnaround - reacting immensely to a challenge to put the customer's needs first.

”



## FORTRESS

“

Fortress' best quality is providing each customer the most robust and safe solution - all while being completely customizable and retaining a high level of quality.

”



## FORTRESS

“

We value suppliers that can help navigate the standards and provide guidance that is directly linked to our applications.

”



## Fortress Global Offices

[www.fortress-safety.com](http://www.fortress-safety.com)

### Fortress Interlocks Ltd

+44 (0)1902 349000  
[sales@fortress-safety.com](mailto:sales@fortress-safety.com)

### Fortress Interlocks USA

+1 (859) 578 2390  
[us@fortress-safety.com](mailto:us@fortress-safety.com)

### Fortress Interlocks China

+86 (021) 6167 9002  
[china@fortress-safety.com](mailto:china@fortress-safety.com)

### Fortress Interlocks Europe

+31 (0)10 7536060  
[europe@fortress-safety.com](mailto:europe@fortress-safety.com)

### Fortress Interlocks Pty Ltd

+61 (0)3 9771 5350  
[australia@fortress-safety.com](mailto:australia@fortress-safety.com)

### Fortress Interlocks India

+91 7042358818  
[india@fortress-safety.com](mailto:india@fortress-safety.com)