

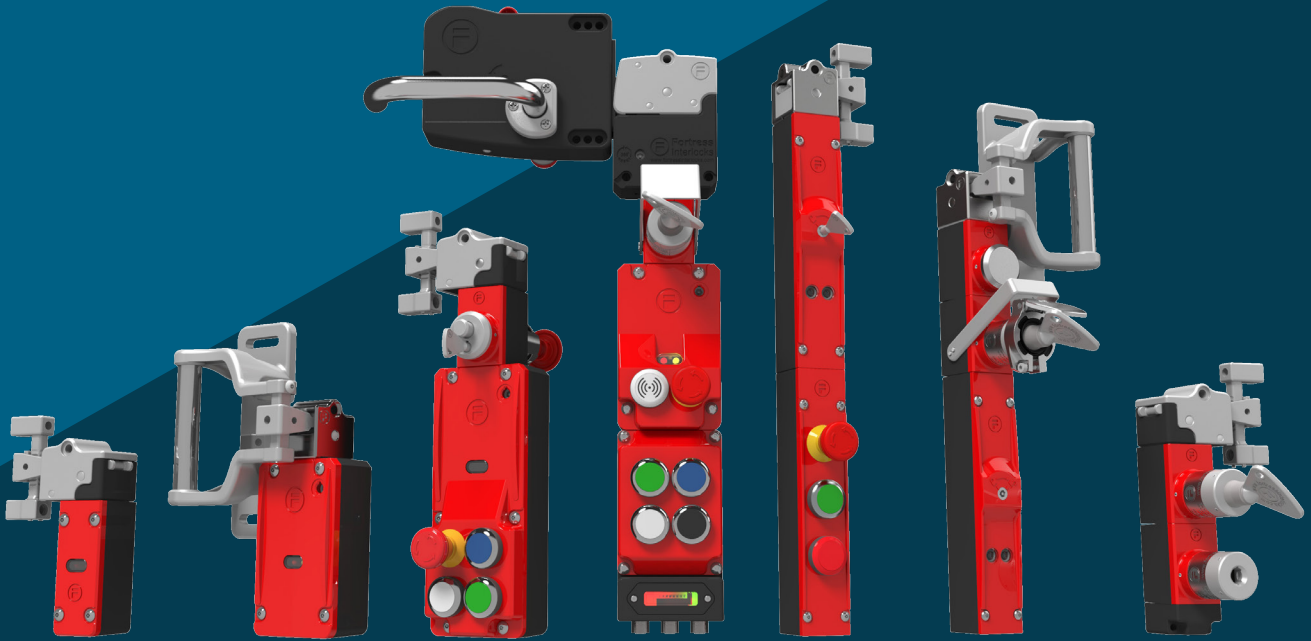

FORTRESS



Heavy Duty Guard Locking with PROFIsafe, CIP Safety and EtherCAT FSoE



Introduction to amGardpro

A configurable interlocking safety solution allows specification of functionality to meet the exact requirements of your application. Interlock monitoring, trapped key, pushbutton controls, and network communication options can be combined into a single unit – providing a cost efficient solution compared to separate devices.

Fortress amGardpro products are designed, tested and 3rd party approved by TÜV SÜD for use in up to PLe/Cat 4 applications.

The robust design and high strength of a Fortress interlock contributes to the ability to use one Fortress interlock in a safety function requiring high reliability (up to PLe).

Trapped key can be used to control access or to protect personnel when whole body access exists through the use of personnel (safety) keys as a proactive inhibit function.

For connectivity, all devices can be specified with a quick disconnect connector and ordered with the correct mating cable in a variety of lengths. If network communication is preferred, this can be integrated by using the *proNet* networked option pod module which supports PROFINET/PROFIsafe, EtherNet/IP CIP safety and EtherCAT/FSoE.

Access Control permissions can be implemented using employee ID cards through FRANK, a software based permissions management system for machine areas. Access data can then support further analysis.

When mounting to machine guarding, mounting plates can be pre-fitted to the Fortress units to reduce fasteners required in installation. 40mm wide variants are also available to fit narrow profiles.

Want to compare and configure a Fortress part number?
You can use our online product configurators at www.fortress-safety.com

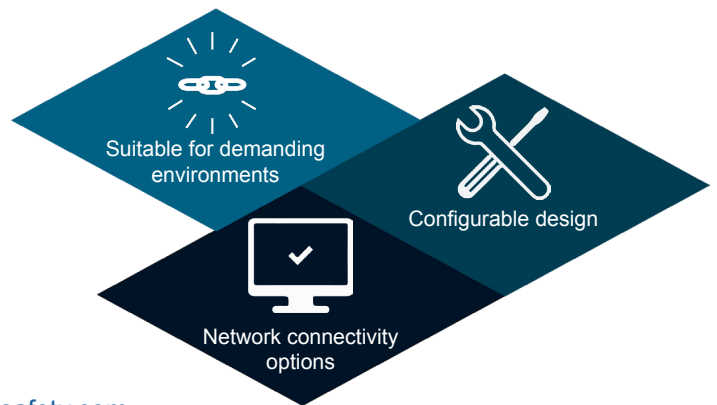

Mechanical Life
1,000,000 Cycles

Robustness
10kN Retention Force

External Certifications
CAT.4 PLe

Customisable

Networking Capability

RFID Access Control
FRANK

Quick Disconnect options

Environmental Resistance
Sealed to IP65 & IP67

DUST

WATER

EtherNet/IP

EtherCAT

PROFINET

ODYA

Application Requirement:

Access points such as hatches or hinged guards can require safeguarding with interlocks to ensure the process cannot run with guards open. Wire-to-the-guard solutions are suited to fast and frequent access demands. Processes that have a run down time may require safeguarding using interlocks with guard locking that only unlock the guard when it is safe to access.

Interlock

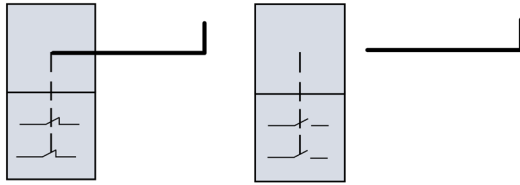

Interlock opens, safety contacts open

Interlock with Guard locking

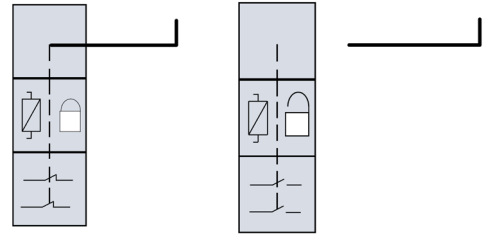

Interlock is locked until machine reaches a safe state, unlocking of the interlock opens safety contacts

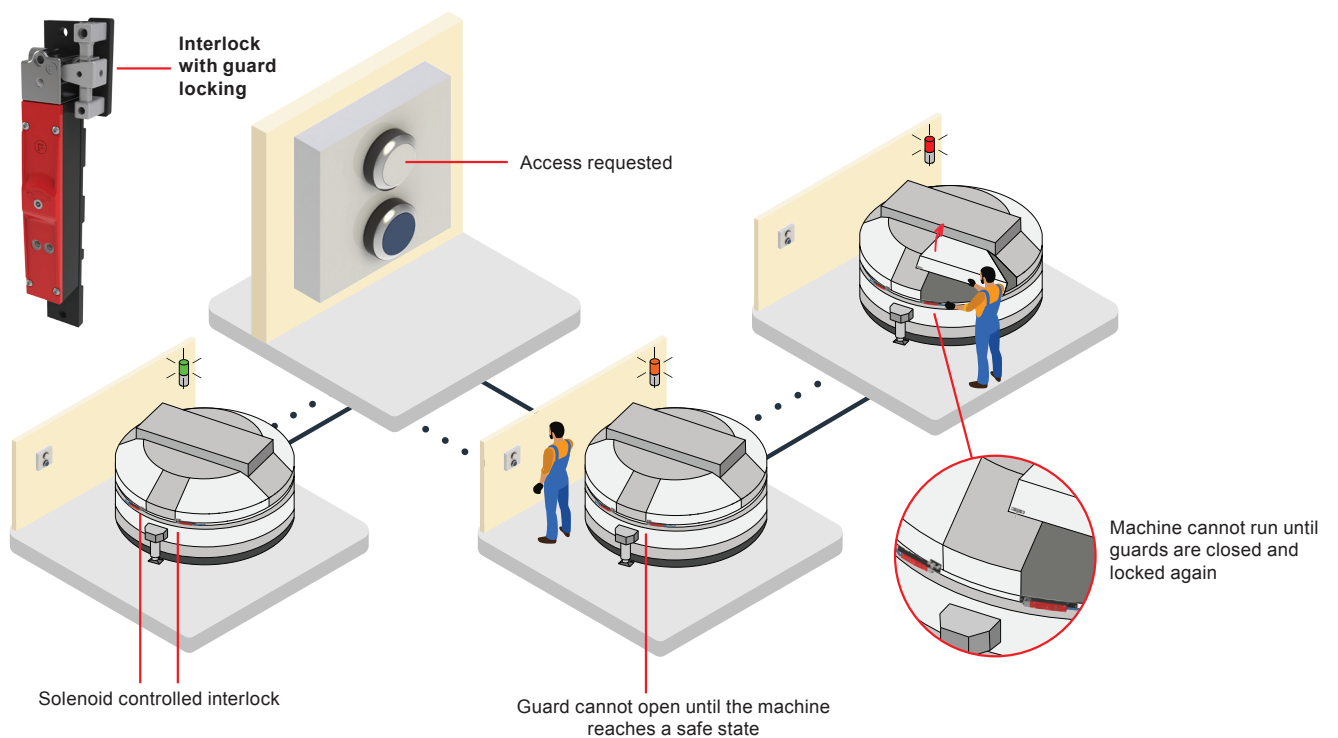
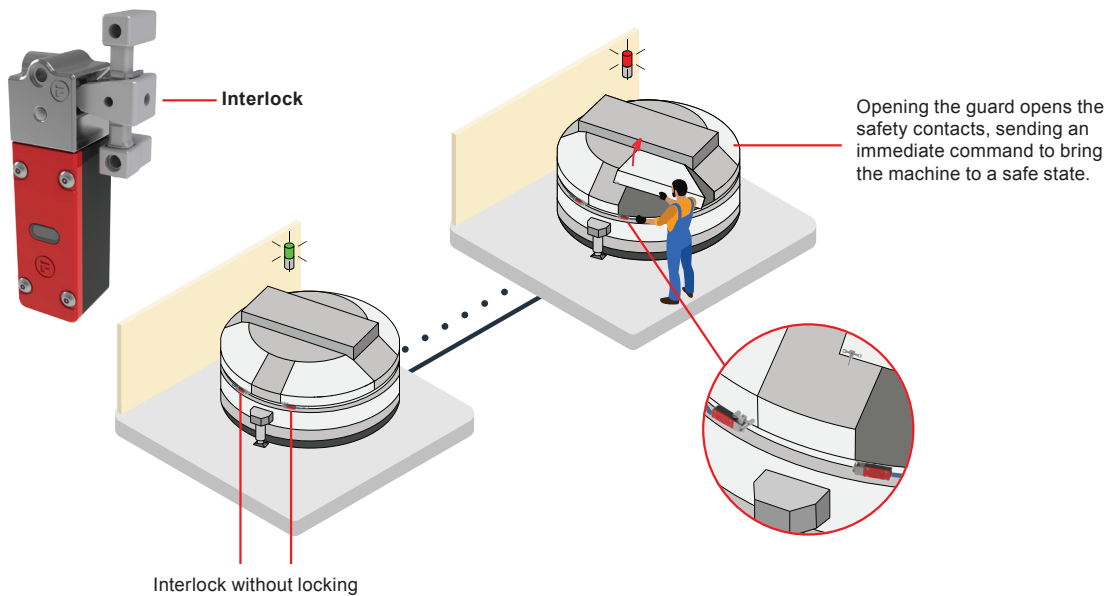

Robot Pallet Stacker

Application Requirement:

Many robot applications require safeguarding. The robot pallet stacker below has two access points and a single control panel. When the system has reached a safe state, the Power-to-Unlock solenoid is energised and access keys are released. Mechanical Trapped Key interlocks at the guard can be opened with an access key whilst also forcing an operator to take a personnel key to prevent unexpected start-up in accordance with ISO 14118.

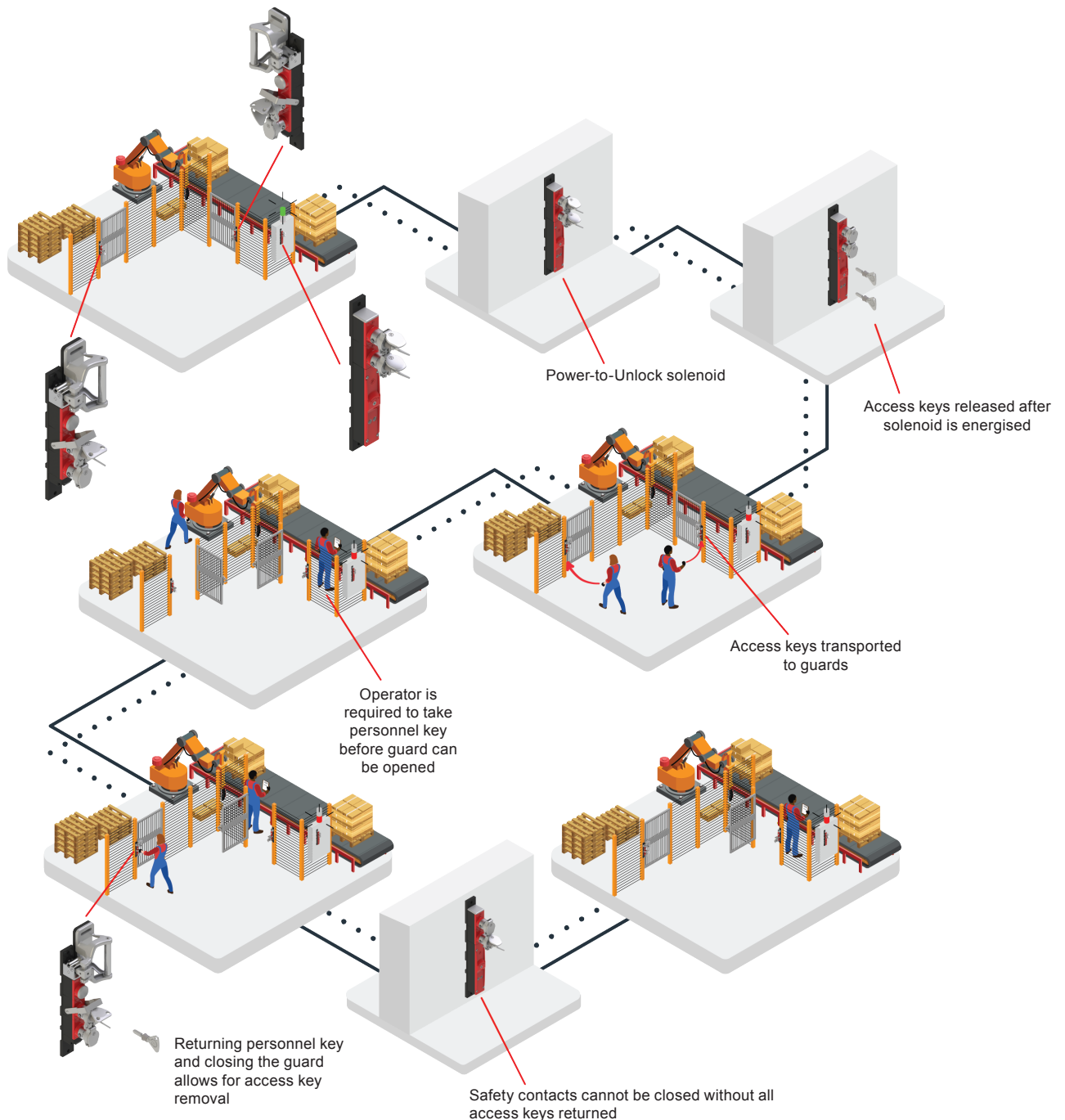
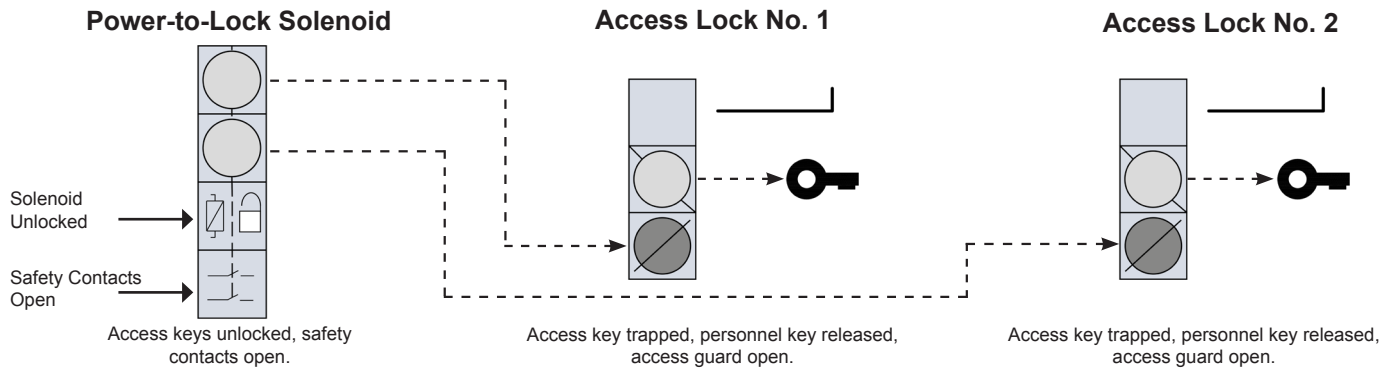

Slitting Line

Application Requirement:

Slitting lines require multiple safeguarding methods to address different hazards. In the below application safety contacts for light curtains, interlocks and rope pull emergency stops (E-Stops) are integrated into two network connected Fortress units. Access permissions are enforced via RFID badges. The Fortress FRANK software manages permissions to restrict access based on training levels. The FRANK software records access information that can be used for productivity analysis.

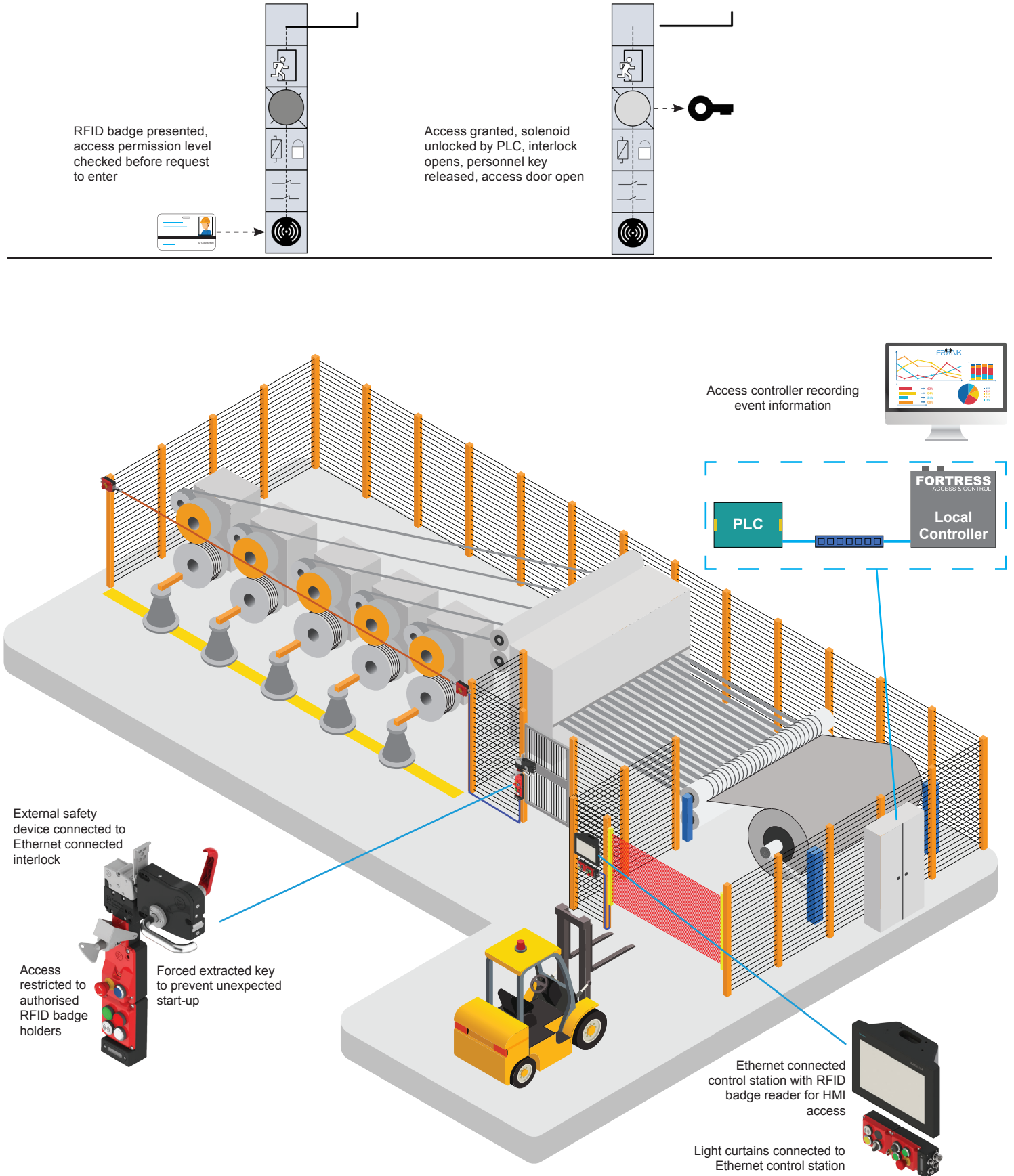

Automated Storage & Retrieval Systems

Application Requirement:

Automated storage and retrieval systems have aisle entry access at aisle ends and / or mid aisle points. In some regions, type-C standards may give specific requirements for these systems. For EN 528:2021 conformance, automatic mode is disabled by a key switch mounted in an enclosure outside the aisle. This key permits access to the aisle via the interlock. The same key enables manual mode via a key switch on the cart inside the aisle.

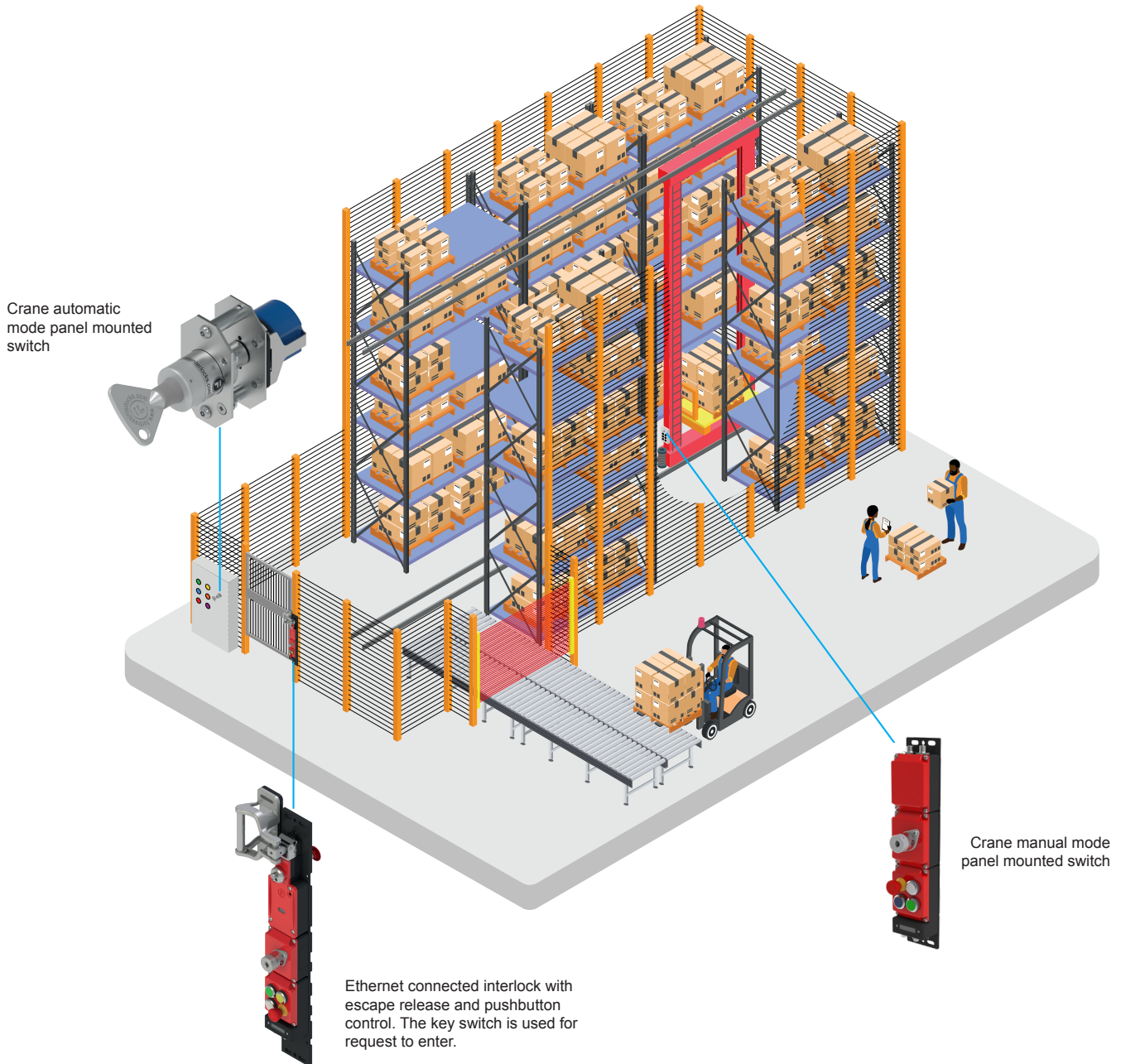
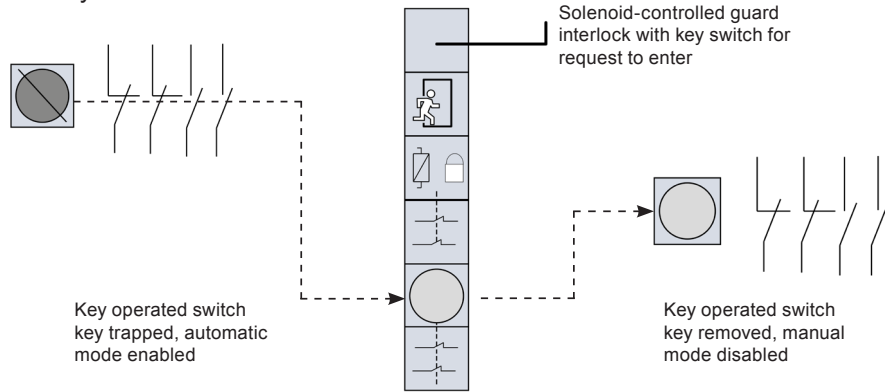

Guard Interlock

Heavy duty interlock with 2 x normally closed (NC), 1 x normally open (NO) contacts

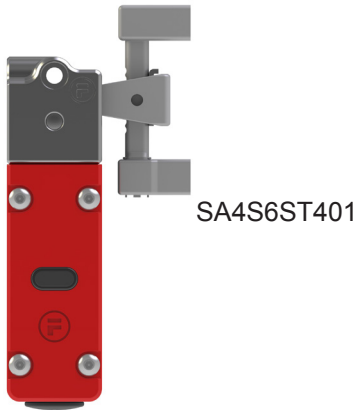

SA4S6ST401

Guard Interlock with Locking and with Forced Extracted Key

Personnel key is required to be taken by the operator before guard opens.



SD2S6EKL3ZL411MPB1

Guard Interlock with Locking

Heavy duty Power-to-Unlock solenoid interlock.



SA2S6ZL411MPB1

Guard Interlock with Locking and with Single Action Escape Release

Ergonomic handle incorporates escape release in a single action. The red escape release handle manually releases locking mechanism and opens guard.



EI2A6SR411

Guard Interlock with Locking and with Escape Release

Heavy duty interlock with escape release. Activation manually releases locking mechanism and creates stop command.



HS1S6R2ZR411

Guard Interlock with Locking and with Integrated Ethernet Communication

PROFINET / PROFIsafe connectivity to the interlock. Pushbuttons & emergency stop incorporated at the guard. EtherNet/IP CIP safety also supported.

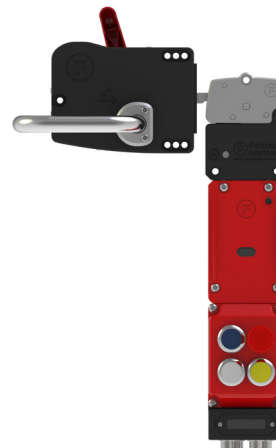

EI2A6SRP11NDP6EIP7P2NPF10

What is *proNet*?

Fortress' *proNet* module allows Fortress devices to connect to PROFINET, EtherNet/IP (E/IP) or EtherCAT networks. Safety I/O is communicated using PROFIsafe, CIP Safety or FSoE (Functional Safety over EtherCAT).

Connector sets for data and power are available to suit daisy-chain and PoE (Power over Ethernet). An integrated ethernet switch allows devices to be daisy-chained together. Device information, supply voltage, and network statistics are available via the device webpage.

The *proNet* module can be configured as part of an *amGardpro* interlock unit or as a standalone control station capable of connecting to external devices via connectors.

When configured with *amGardpro* modules to create a networked interlock, 3 dual channel safety inputs are available alongside standard I/O for pushbuttons and lamps. In addition to Interlock monitoring, it is possible to configure an emergency stop as well as a connection to an external safety device.

Control Stations

Fortress' *proNet* control stations are configurable network solutions aimed at reducing the cost of installation / ownership compared to fabricated custom controls or operator interface.

Costs associated with wiring time, panel building, panel space and the purchasing of enclosures, I/O modules, terminals, multi core cables and connectors for safety devices can be avoided. Units arrive ready to be connected into the network.

proNet Control Stations are available with both safety and standard I/O or with standard I/O only. To provide additional I/O positions, Option Pods are added to the control station assembly up to a 3x3 arrangement.

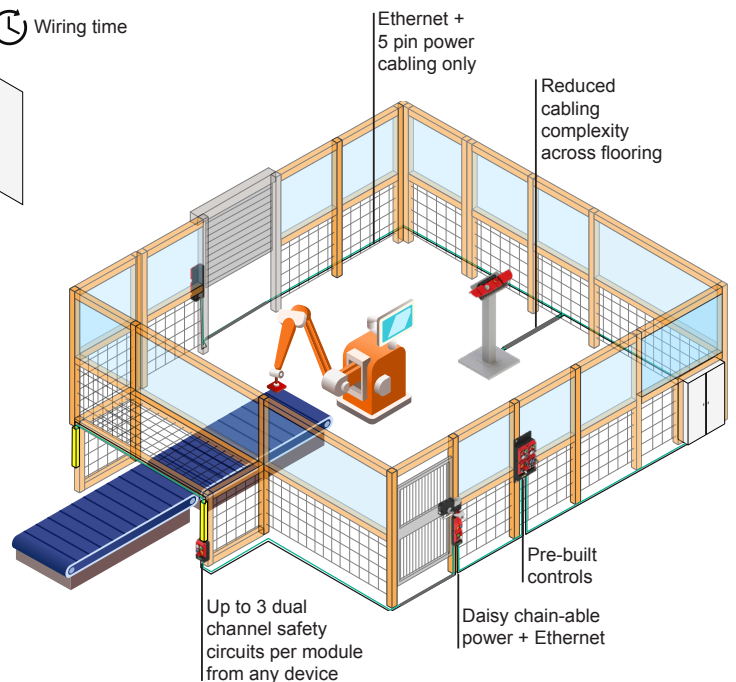
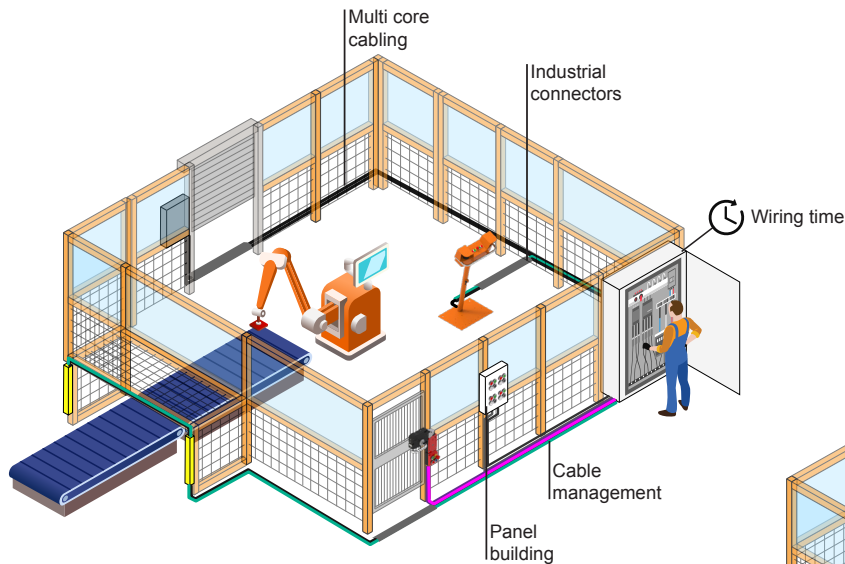
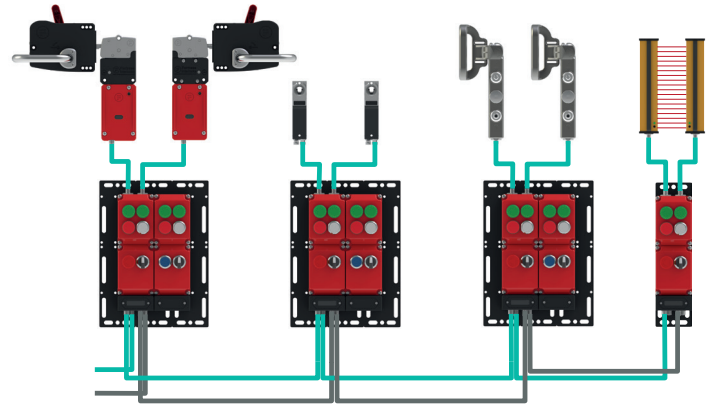

Industrial Access Control with FRANK

Fortress RFID Access Network Keys

FRANK allows simple “access granted” and other permissions to be communicated from a Fortress Interlock or Control Station back to the PLC.

With integrated RFID readers to suit existing site ID cards, Fortress devices and FRANK software allow easy implementation of a permissions management system.

Event data of who, when and where is collated to allow viewable events lists and data insights that can support efficiency analysis.

Fortress readers support common card types across 13.56MHz and 125KHz frequencies.

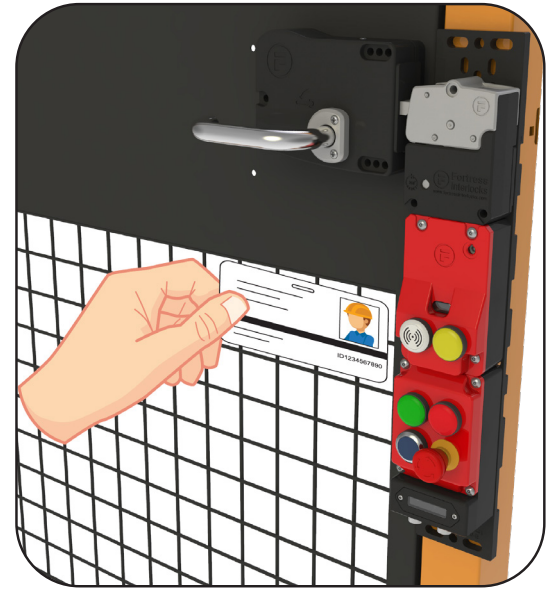

Control Access

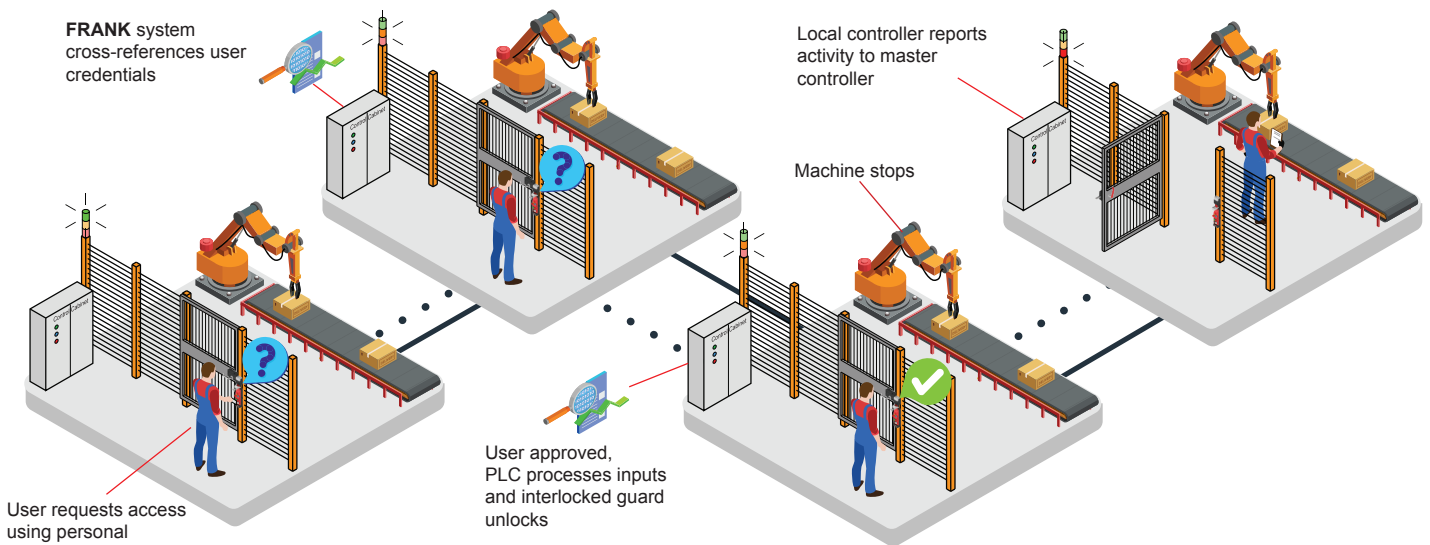

Improve Productivity

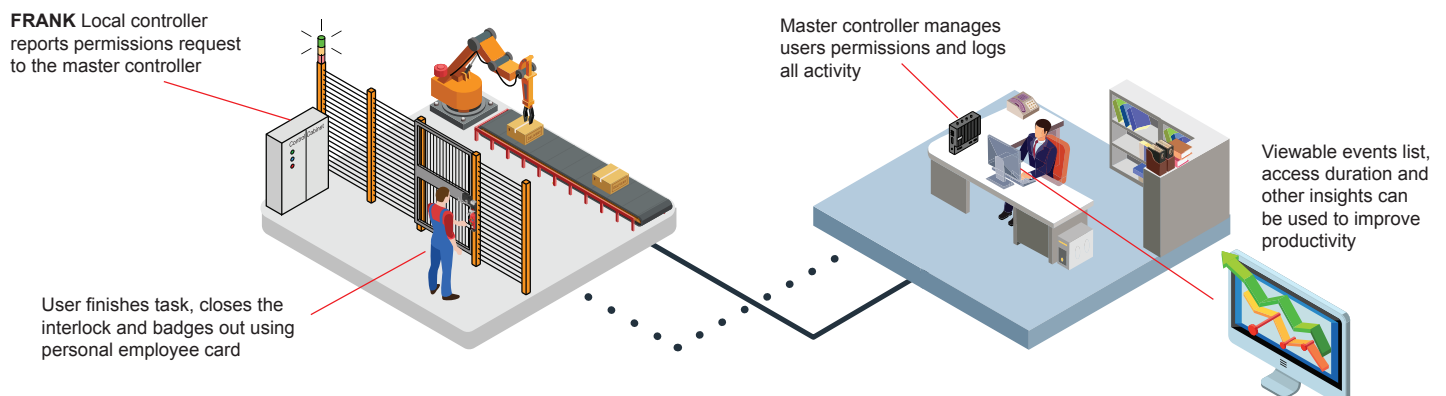

Misalignment Capability

Recognising that machine guarding installations often have a degree of variability and that guards move over time during use, Fortress provides market leading misalignment capability in our actuator offerings.

Actuators can be moved vertically with angular misalignment also absorbed by actuator design.

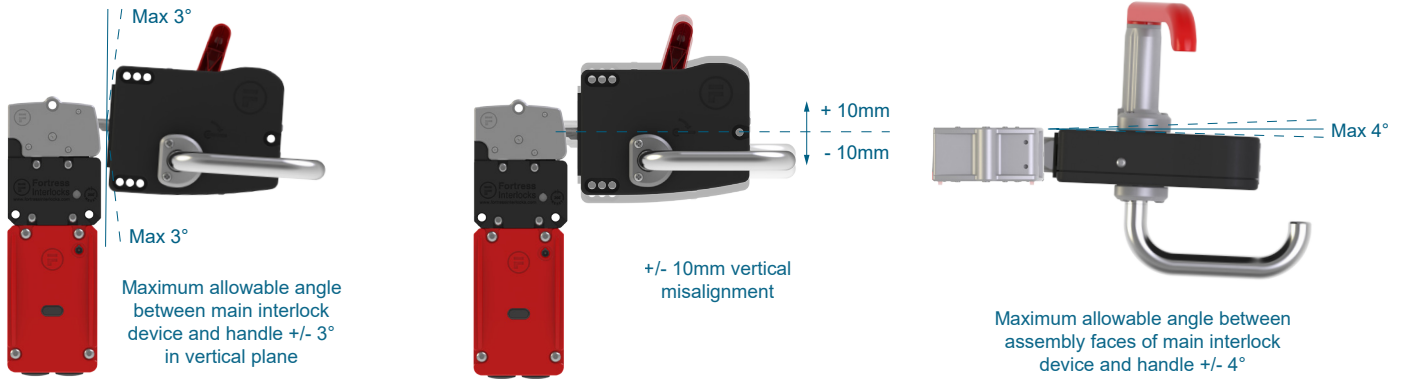

Mounting Plates

A series of packing and mounting plates to ensure most configured amGard pro interlocks can easily and simply be fitted to machine guarding. The configurable plates are a robust aluminium design and are suitable for both hinged and sliding guards. The packing and mounting plates are pre-fitted to the interlock when the interlock and mounting plates are ordered together. However, they can also be ordered separately.

Without Mounting Plates

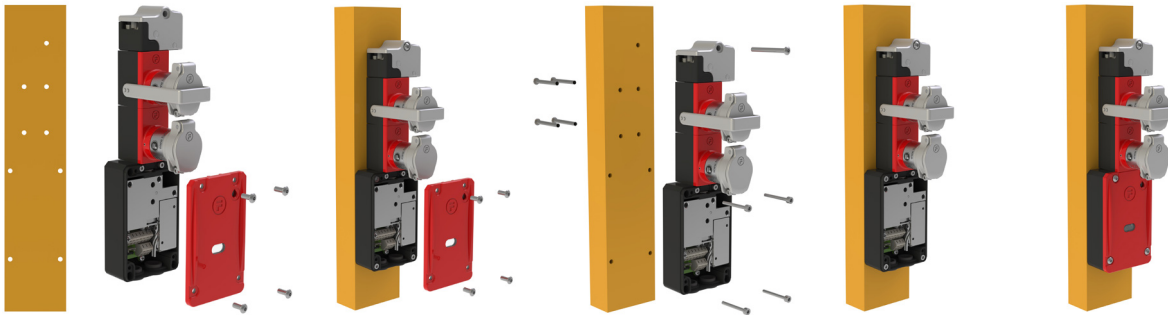

With Mounting Plates

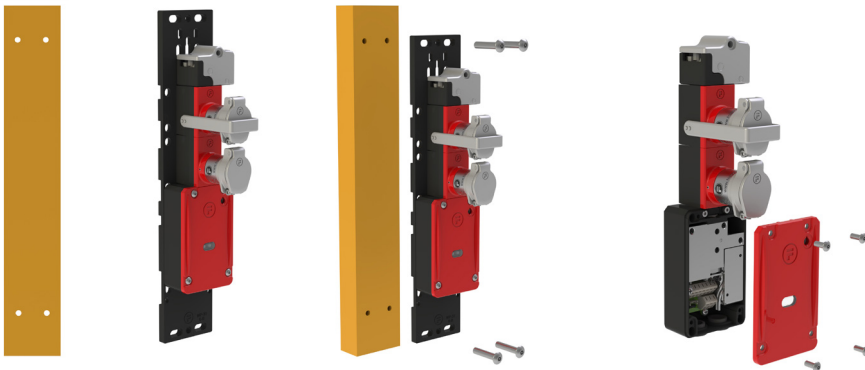

How to Configure:

The amGard pro online configurator allows you to add a mounting plate at the end of your configuration which will automatically select the correct mounting plate that your configured unit requires.

Actuator

Heads

Tongue



Handle Actuator

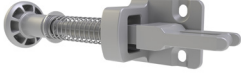

Short Hinged Handle



Long Hinged Handle



Slidebar



Rotary Insertion Handle



Mechanical Ends

Cap

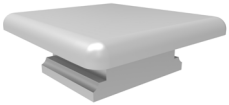

Ergonomic Handle, No Interior Handle



Ergonomic Handle, Open & Close from Both Sides



Accessories

Padlockable Drop Down

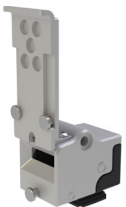

Padlockable Hasp for Interlock Blocking - Head Mounted



Single Action Escape Release Handle



Linear Insertion Head for Slimline (40mm)



Rotary Insertion Head



Linear Insertion Head



Single Action Escape Release Head



Escape Release Adaptors

Auxiliary Key Tool and External Button Reset



External Button Reset



Trapped Key Adaptors

Extracted Key Adaptor



Personnel (Safety) Key Adaptor



Access Key Adaptor



Mounting Plates

Tongue & Rotary Insertion Handle



Ergonomic Handle



Interlock Body LOK Modules

Solenoid Controlled Slimline (40mm) LOK Body



Solenoid Controlled LOK Body



Non Solenoid LOK Body



Slidebar



Hinged Handle



Option Pods

Slimline (40mm) Pod



Key Switch Pod



Option Pod



Networked Option Pod



40 mm



80 mm

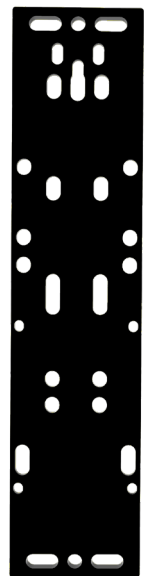

Mechanical Ends

Foot

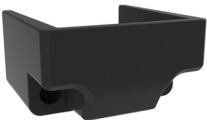

5 Pin M12



8 Pin M12



10 Pin M12



12 Pin M12



19 Pin M23



Power & Data Connector Sets



Quick Disconnects

Step 1: Choose the Actuator & Handing

For use with Linear Insertion Slimline Head

Description	Information	Part No.
Linear insertion tongue	High strength and misalignment, suitable for all 'S' head configurations.	SA

Description	Information	Part No.
Tongue sidebar without a spring	With no return spring sidebar remains in the position it is left in.	SN

Description	Information	Part No.
Tongue sidebar with return spring	Return spring pulls the sidebar open when unlocked. Avoids collision with interlock when closing the guard.	SS

Description	Information	Part No.
Short hinged handle	Short reach for use with 40mm wide units. (Removes need for separate handle on hinged guards).	HS1

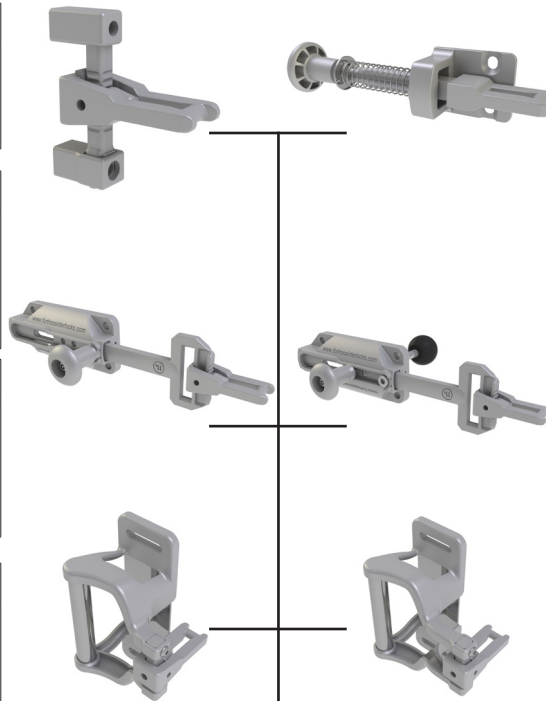

Description	Information	Part No.
Hand operated	Hand operated actuator with return spring.	SD

Description	Information	Part No.
Tongue sidebar with internal handle but no return spring	Sliding motion holds door closed. Same as a SN but internal handle allows door to be opened only from the inside when main unit is unlocked.	SI

Description	Information	Part No.
Slimline tongue sidebar with internal handle comes with spacer behind the knob	Same as a SI but internal handle allows door to be opened and closed from the inside when main unit is unlocked.	SF

Description	Information	Part No.
Long hinged handle	Long reach hinged handle for use with 80mm wide units.	HL1

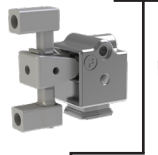
Description Front facing	Part No. 1		Description Rear facing	Part No. 3
Description Left facing	Part No. 2		Description Right facing	Part No. 4



Description	Information	Part No.
Linear insertion slimline head	High strength and durability, suitable for all 'S' actuators and front / left / rear / right facings.	S6

Insert your part number selection here	Actuator	Handing	Head	Push Escape Release Adaptor	Trapped Key Adaptors			Interlock Body LOK Module

Step 1: Choose the Actuator & Handing

For use with Linear Insertion Head

Description	Information	Part No.
Linear insertion tongue	High strength and misalignment, suitable for all 'T' head configurations.	TA

Description	Information	Part No.
Slidebar without a spring	With no return spring, the slidebar remains in the position it is left in.	TN

Description	Information	Part No.
Slidebar with a return spring	Return spring pulls the slidebar open when unlocked. Avoids collision with interlock when closing the guard.	TS

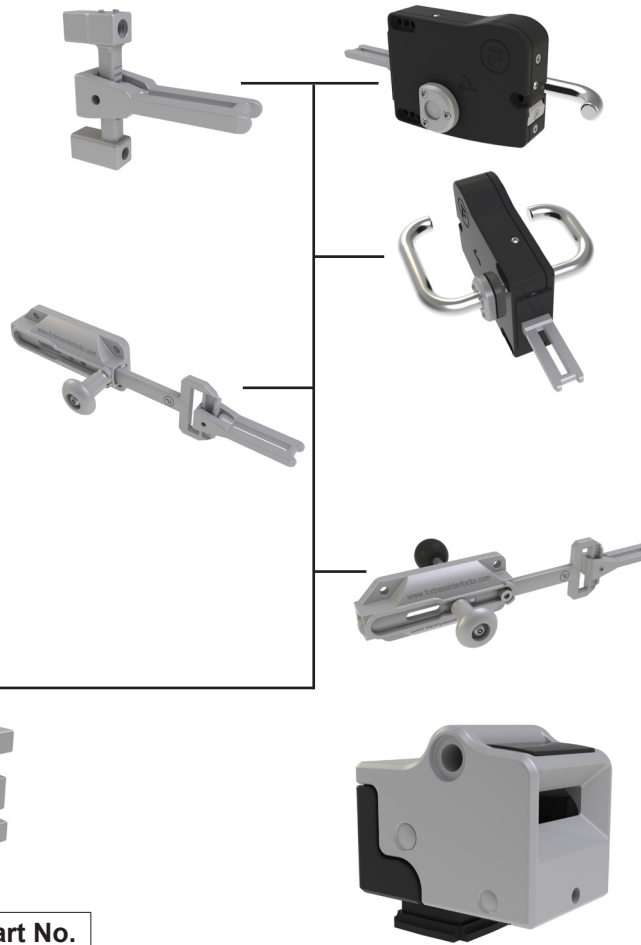

Description	Information	Part No.
proHandle no internal release	Ergonomic handle for machine guarding, but no method to open guard from inside.	EN

Description	Information	Part No.
proHandle, with internal access handle	Ergonomic handle for machine guarding. Internal access handle allows to be opened and closed from the inside.	EF

Description	Information	Part No.
Slidebar with internal handle but no return spring	Same as a TN but internal handle allows door to be opened only from the inside when main unit is unlocked.	TI

Description	Information	Part No.
Slidebar with internal handle comes with spacer behind the knob	Same as a TN but internal handle allows door to be opened and closed from the inside when main unit is unlocked.	TF

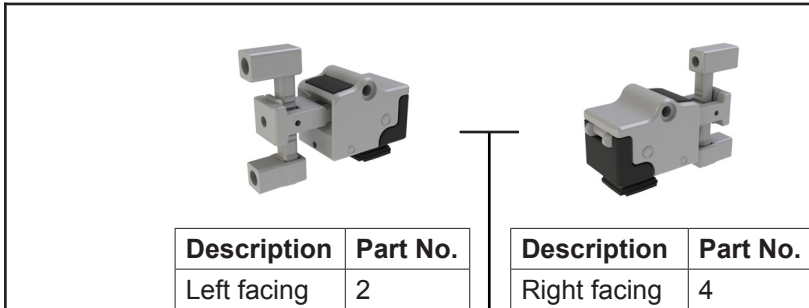

Description	Information	Part No.
Linear insertion head	High strength and durability, suitable for all 'T' actuators and left / right facings.	T6

Insert your part number selection here	Actuator	Handing	Head	Push Escape Release Adaptor	Trapped Key Adaptors			Interlock Body LOK Module

Step 1: Choose the Actuator & Handing

For use with Rotary Insertion Head

Description	Information	Part No.
Rotary insertion handle	Turning motion holds door closed. Ideal for non locking set ups.	MA



Description	Information	Part No.
Rotary insertion head	Rotary insertion head suitable for MA actuator and left / right facings.	M6

Step 1: Choose the Actuator & Handing

For use with Single Action Escape Release Head

Description	Information	Part No.
Single action escape release handle	Red handle releases all locking mechanisms and opens safety contacts to allow escape release.	EI



Description	Information	Part No.
Single action escape release handle with additional function	Red handle releases all locking mechanisms and opens safety contacts to allow escape release. Red handle can also be used to close the interlock from the inside.	EJ



Description	Information	Part No.
Single actions escape release head	Single action escape release head with automatic reset after escape release. Suitable for EI and EJ handle actuators and left / right facings.	A6
Single actions escape release head with key reset	Single action escape release head with key reset after escape release. Suitable for EI and EJ handle actuators and left / right facings.	I6

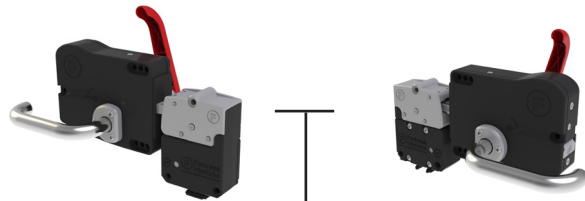

Description	Part No.
Left facing	2

Description	Part No.
Right facing	4

Insert your part number selection here	Actuator	Handing	Head	Push Escape Release Adaptor	Trapped Key Adaptors			Interlock Body LOK Module

Step 2: Do you want a Push Escape Release?

Description

A push escape release adaptor will allow guard to open even if unit is locked by keys and / or solenoid. A push escape release adaptor is not needed if a single action escape release head and handle combination have already been specified.

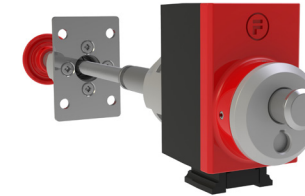

Description	Information	Part No.
External Button Reset	Releases all locking mechanisms and opens safety contacts to allow escape release. Simple push reset allows quick restart. Suitable for guards up to 60mm thick.	RX

Description	Information	Part No.
External Button Reset with variable length	Same as RX but suitable. For guards up to 300mm thick.	RZ



Description	Information	Part No.
Auxiliary Key Tool and External Button Reset	Same as RX but with key reset.	R2

Description	Information	Part No.
Auxiliary Key Tool and External Button Reset with variable length	Same as R2 but suitable. For guards up to 300mm thick.	R4

am
Requiring a keyed reset of the escape release can ensure incidents are reported.

am
If a push escape release is not required leave part number blank and go to step 3.

Insert your part number selection here	Actuator	Handing	Head	Push Escape Release Adaptor	Trapped Key Adaptors			Interlock Body LOK Module

Step 3: Choose a Trapped Key Adaptor

Forced extracted key for personnel to carry inside area



Additional personnel (safety) keys - SK



Access key required to unlock the interlock - AK



am
If you've selected an I6 / I7 / A6 / A7 or a push escape release adaptor then select a releasing lock.

Description	Part No.
Standard lock	L
Releasing lock (must be used if a push escape release or single action escape release head & handle selected).	R

Description	Part No.
Standard lock no dustcover	1
Standard lock with dustcover	2
Standard lock with padlockable dustcover	3
Masterable lock no dustcover	6
Masterable lock with dustcover	7
Masterable lock with padlockable dustcover	8

Description	Part No.
Standard lock	L
Releasing lock (must be used if a push escape release or single action escape release head & handle selected).	R

Description	Part No.
Standard lock no dustcover	1
Standard lock with dustcover	2
Standard lock with padlockable dustcover	3
Masterable lock no dustcover	6
Masterable lock with dustcover	7
Masterable lock with padlockable dustcover	8

Description	Part No.
Number of key adaptors required	1 - 9

am
Maximum number of Trapped Key Adaptors is 9.

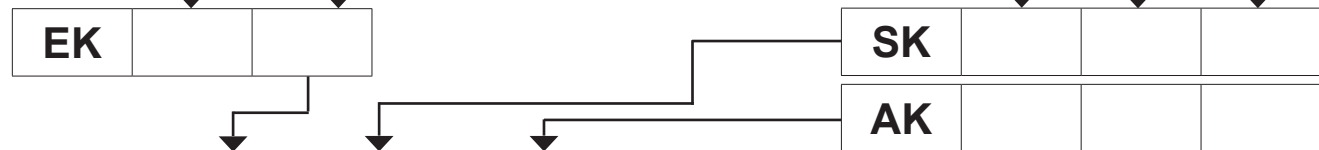

Insert your part number selection here	Actuator	Handing	Head	Push Escape Release Adaptor	Trapped Key Adaptors			Interlock Body LOK Module

Step 4: Choose an Electrical Switching / Interlock Body LOK Modules

Description	Information	Part No.
Slimline LOK body	Solenoid controlled interlock. Holds door locked until signal sent to unlock. Only 40mm wide.	ZL
Slimline LOK body - releasing	Same as ZL but allows push escape release adaptor to manual release locking means. Only 40mm wide.	ZR

Description	Information	Part No.
LOK body	Solenoid controlled interlock. Holds door locked until signal sent to unlock. 80mm wide.	SL
LOK body - releasing	Same as SL but allows push escape release adaptor or single action escape release head and handle to manual release locking means. Only 80mm wide.	SR

Description	Information	Part No.
STOP body	Interlock without locking.	ST



Voltage Options	Part No.
24v	4
proNet connection (80mm wide variants only)	P
110v (80mm wide variants only)	1
230v (80mm wide variants only)	2
ASi (80mm wide variants only)	8

Solenoid Type & Manual Release Options	Part No.
No locking (ST units only)	0
Power-to-Unlock auxiliary release	1
Power-to-Unlock emergency release	2
Power-to-Lock (24v, 110v & ASi only)	6

Safety Switching Principle Options	Part No.
Safety contacts open when unlocked. For guard locking or locking for the protection of process.	1
Safety contacts open when interlock is opened or when first operated key is used, not when the device is unlocked. This is always selected for Power-to-Lock units.	6

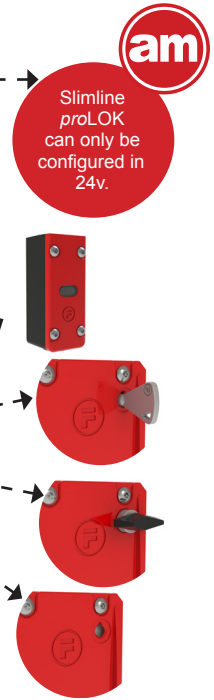

am
If you have selected a push escape release adaptor or single action escape release head and handle then select a releasing lock.

am
If no additional control functionality is required, skip to wiring step 9.

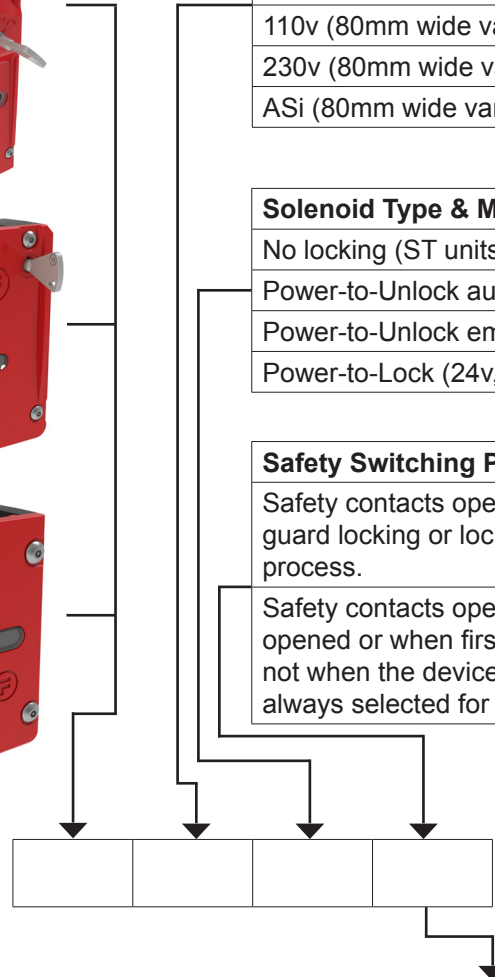

Insert your part number selection here	Actuator	Handing	Head	Push Escape Release Adaptor	Trapped Key Adaptors			Interlock Body LOK Module

Control Options - Once the basic interlock configuration is established, control functions can be added in 'Option Pods'

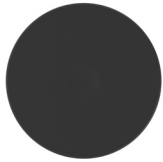

00
Blank



LR
Red Lamp



LY
Yellow Lamp



LG
Green Lamp



LB
Blue Lamp



LW
White Lamp



Laser Engraving
2 lines of 8 characters



ET
E-Stop (twist reset)



EP
E-Stop (pull reset)



EI
E-Stop (illuminated twist reset)



EM
E-Stop (with additional monitoring contacts, twist reset)



2E
Latching Selector Switch (illuminated)



2F
Momentary Selector Switch (illuminated)



K5
Latching Key Switch (90 degree)



PB
Black Non Illuminated Pushbutton

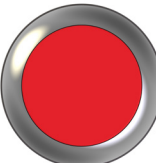

P1
Red Illuminated Pushbutton

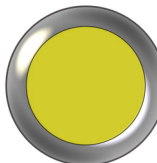

P2
Yellow Illuminated Pushbutton

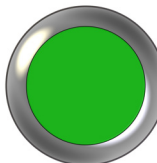

P3
Green Illuminated Pushbutton



P6
Blue Illuminated Pushbutton



P7
White Illuminated Pushbutton

am
2E, 2F & K5 options can only be fitted in top right or bottom left position.



Laser Engraving:
2 lines of 8 characters



RG
RFID Reader

am
Please contact Fortress to confirm your specific RFID reader.

am
If you don't require any additional control function, skip to step 9.

Step 5: Slimline Option Pods



Individual power supply units are available on request.

Description	Part No.
Standalone slimline pod with common power supply.	V
Slimline pod to be fitted below STOP or slimline LOK module with common power supply.	K



Select your pushbuttons, selector switches and lamps from the control option section in this ordering sequence:

1. Top position
2. Middle position
3. Bottom position



If an option pod isn't required, skip to wiring step 9.



Insert your part number selection here	Actuator	Handing	Head	Push Escape Release Adaptor	Trapped Key Adaptors			Interlock Body LOK Module	Slimline Option Pod

Step 6: Key Switch Pods



Description	Part No.
Standalone key switch pod with no holes on top of pod case.	0
Key switch pod with two holes on top for fitting to guard interlock assembly.	2

Description	Part No.
Standard Lock no dustcover	1
Standard Lock with dustcover	2
Standard Lock with padlockable dustcover	3
Masterable Lock no dustcover	6
Masterable Lock with dustcover	7
Masterable Lock with padlockable dustcover	8



am
2NO / 2NC safety contacts activated by key and separate from locking switches. Common uses are to request machine stop, to enable modes of operation or prevent machine restart.



Insert your part number selection here	Actuator	Handing	Head	Push Escape Release Adaptor	Trapped Key Adaptors			Interlock Body LOK Module	Key Switch Option Pod

Step 7: Option Pods

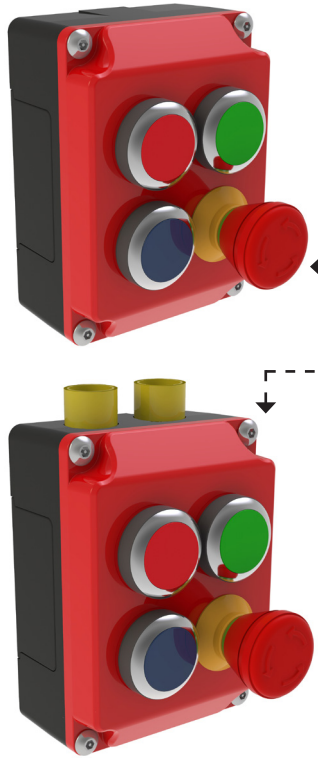

Description	Part No.
Standalone option pod with no holes on top of pod case.	V
Option pod with two holes on top of pod case for fitting to proLOK body.	J



Select your pushbuttons, selector switches and lamps from the control option section in this ordering sequence:

1. Top left
2. Top right
3. Bottom left
4. Bottom right

Non-Contact Sensors 24v only			
Part No.	Description	Handing	Coding Level
N			
C	Magnetic NCS (reed switch)	Left	Low
D	Magnetic NCS (reed switch)	Right	Low
F	Magnetic NCS (hall effect)	Left	Low
J	Magnetic NCS (hall effect)	Right	Low
X	RFID NCS	Left	High
Q	RFIC NCS	Right	High

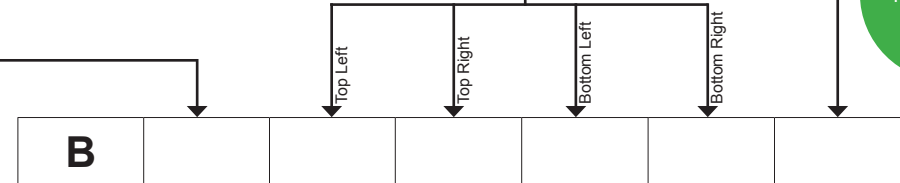

Insert your part number selection here	Actuator	Handing	Head	Push Escape Release Adaptor	Trapped Key Adaptors			Interlock Body LOK Module	Option Pod

Step 8: Networked Option Pods with Interlock Modules



If you have selected a *proNet* Option Pod then your *amGuard pro* unit is now complete. If a *proNet* Option Pod isn't required, skip to wiring step 9.

Description	Network
PROFINET with PROFIsafe to suit interlock module	D
EtherNet/IP with CIP Safety to suit interlock module	H
EtherCAT with FSoE Safety to suit interlock module	M

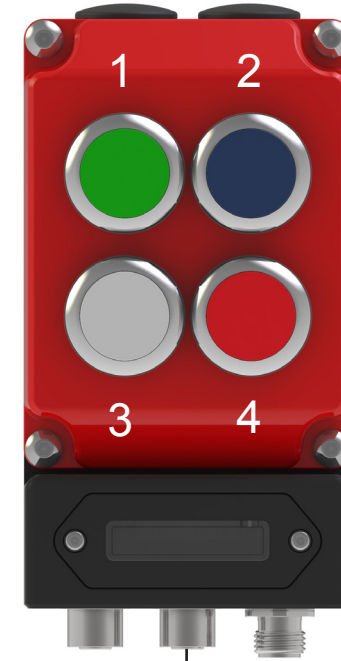

Select your pushbuttons, selector switches and lamps from the control option section in this ordering sequence:

1. Top left
2. Top right
3. Bottom left
4. Bottom right

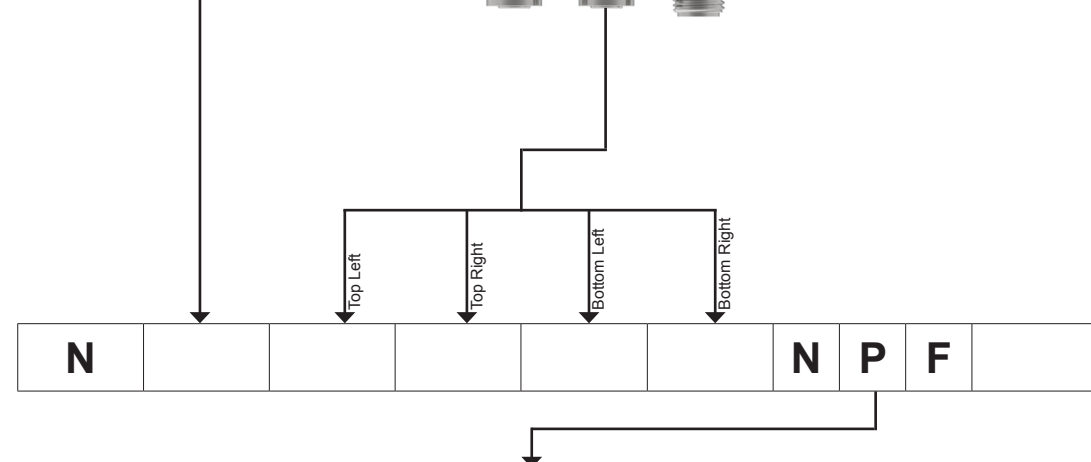

Insert your part number selection here	Actuator	Handing	Head	Push Escape Release Adaptor	Trapped Key Adaptors			Interlock Body LOK Module	Networked Option Pod

Step 8: Networked Option Pods as Control Stations



Networked Option pods can also be configured without interlock components to create custom Control Stations

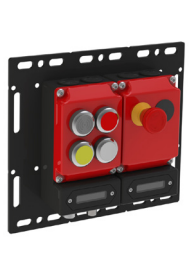

Arrangement is described by a two digit number showing the number of pods first by height and then width.

Part No.	1 x Width	2 x Width	3 x Width
3 x Height	 31	 32	 33
2 x Height	 21	 22	 23
1 x Height	 11	 12	 13

Description	Part No.	
The Orientation of Cable Entry will ensure any pushbutton engravings or text will be rotated to match. Orientation of Cable entry does not affect pushbutton location. Pushbutton locations are selected first as if the PF connectors are at the bottom of the device (B orientation).	Mounting Orientation (described by Cable Entry direction)	
Cables should be mounted on the TOP	T	
Cables should be mounted on the BOTTOM	B	
Cables should be mounted on the LEFT	L	
Cables should be mounted on the RIGHT	R	

Description	Part No.
PROFINET with PROFIsafe	ND
EtherNet/IP with CIP Safety	NH
EtherCAT with FSoE Safety	NM

Select your pushbuttons, selector switches and lamps from the control option section in this ordering sequence.

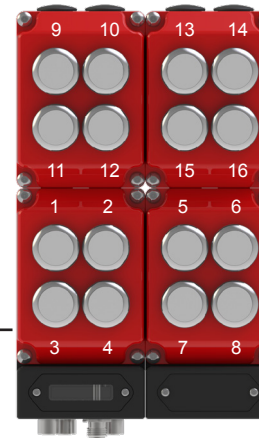

Description		
Connectors can be added for external I/O. See quick disconnect connector options later in this document.		
Part Number		
Left QD	Right QD	Wiring diagram number (Provided by Fortress)

Insert your part number selection here	Control Station	Mounting Plate	Network	Arrangement	Pushbutton configuration			Orientation of Cable Entry	External I/O Connector	Connector	
	CON	MPB1			Pod 1	Additional Pods			PF	*	
						REPEAT					

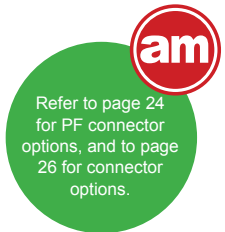

Quick Disconnects

Step 9: Quick Disconnect Connector Options

am
Select a quick disconnect connector to reduce installation with pre-wired devices.



am
amGardpro devices may have one or two connectors. Select the left and right connector accordingly.

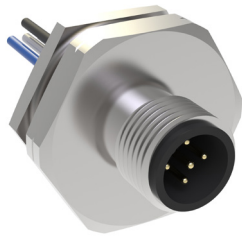

D1
5 Pin M12 QD

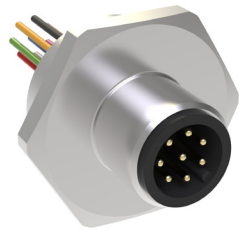

D3
8 Pin M12 QD

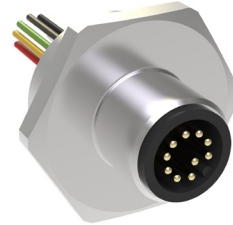

D7
10 Pin M12 QD



D8
12 Pin M12 QD

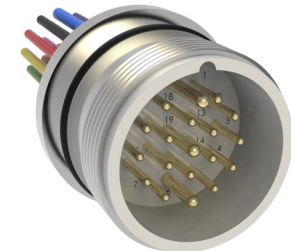

F2
19 Pin M23 QD

am
amGardpro units can be wired to a standard or customer wiring scheme.

am
For Wiring Diagram No. contact your Fortress representative.

Wiring Diagram No.	Left	Right

Insert your part number selection here	Actuator	Handing	Head	Push Escape Release Adaptor	Trapped Key Adaptors			Interlock Body LOK Module	Option Pod	Quick Disconnects	Mounting Plates

Step 10: Accessories

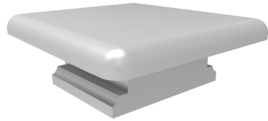

Description	Information	Part No.
Cap	To terminate assemblies without heads.	C6

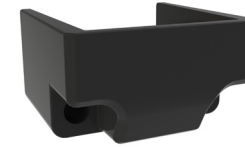

Description	Information	Part No.
Foot	To terminate non-switch configurations.	FT

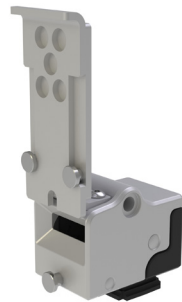

Description	Information	Part No.
Padlockable Drop Down	Padlockable addition to amGardpro head modules. Padlock holes only align when actuator is removed.	DD7

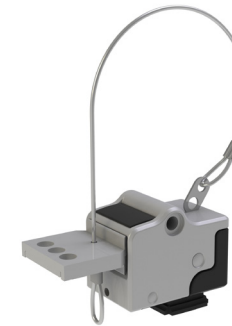

Description	Information	Part No.
Padlockable Hasp for Interlock Blocking - Head mounted	Padlockable addition to amGardpro head modules. 3 x 8mm padlock holes only align when clip is fixed into head.	SL8 - suitable for 'S' head
		TL8 - suitable for 'T' head



FORTRESS

FORTRESS

“ We have the peace of mind that our workers are safe and protected by Fortress equipment. ”



FORTRESS

“ Fortress’ best quality is providing each customer the most robust and safe solution - all while being completely customizable and retaining a high level of quality. ”



FORTRESS

“ Fortress is best at providing customised solutions at a rapid turnaround - reacting immensely to a challenge to put the customer’s needs first. ”



FORTRESS

“ We value suppliers that can help navigate the standards and provide guidance that is directly linked to our applications. ”



Fortress Global Offices and Manufacturing Facilities

www.fortress-safety.com

Fortress Interlocks Ltd

+44 (0)1902 349000

Fortress Interlocks Pty Ltd

+61 (0)3 9771 5350

Fortress Interlocks Europe

+31 (0)10 7536060

Fortress Interlocks China

+86 (021) 6167 9002

Fortress Interlocks USA

+1 (859) 578 2390

Fortress Interlocks India

+91 7042358818

Contact us



Notes

